

VACON[®] 100 HVAC
AC DRIVES

APPLICATION MANUAL

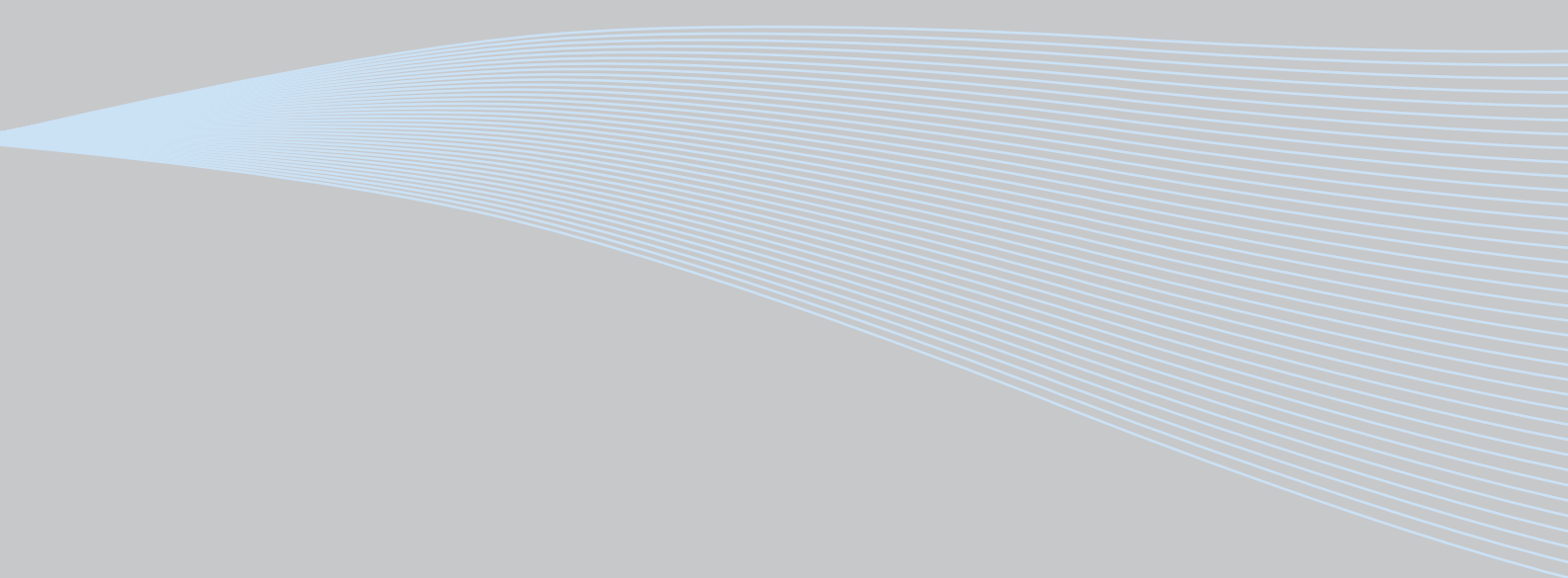

PREFACE

Document ID:	DPD01696J
Date:	4.2.2015
Software version:	FW0065V030

ABOUT THIS MANUAL

This manual is copyright of Vacon Plc. All Rights Reserved.

In this manual, you can read about the functions of the Vacon® AC drive and how to use the drive. The manual has the same structure than the menu of the drive (chapters 1 and 4-8).

Chapter 1, Quick Startup Guide

- How to start the work with the control panel.

Chapter 2, Wizards

- Setting up an application quickly.

Chapter 3, User Interfaces

- The display types and how to use the control panel.
- The PC tool Vacon Live.
- The functions of the fieldbus.

Chapter 4, Monitoring menu

- Data on the monitoring values.

Chapter 5, Parameter menu

- A list of all the parameters of the drive.

Chapter 6, Diagnostics menu

Chapter 7, I/O and Hardware menu

Chapter 8, User settings, favourites and user level menus

Chapter 9, Parameter descriptions

- How to use the parameters.
- Digital and analogue input programming.
- Application-specific functions.

Chapter 10, Fault tracing

- The faults and their causes.
- Resetting the faults.

This manual includes a large quantity of parameter tables. These instructions tell you how to read the tables.

Index	Parameter	Min	Max	Unit	Default	ID	Description
							

- | | |
|-----------------------------------------------------------------------------------------------------------------------------------------------------------------------------------------------------------------------------------------------------------------------------------------------------------|---------------------------------------------------------------------------------------------------------------------------------------------------------------------------------------------------------------------------------------------------------------------------------------------|
| <p>A. The location of the parameter in the menu, that is, the parameter number.</p> <p>B. The name of the parameter.</p> <p>C. The minimum value of the parameter.</p> <p>D. The maximum value of the parameter.</p> <p>E. The unit of the value of the parameter. The unit shows if it is available.</p> | <p>F. The value that was set in the factory.</p> <p>G. The ID number of the parameter.</p> <p>H. A short description of the values of the parameter and/or its function.</p> <p>I. When the symbol shows, you can find more data about the parameter in Chapter Parameter descriptions.</p> |
|-----------------------------------------------------------------------------------------------------------------------------------------------------------------------------------------------------------------------------------------------------------------------------------------------------------|---------------------------------------------------------------------------------------------------------------------------------------------------------------------------------------------------------------------------------------------------------------------------------------------|

NOTE! You can download the English and French product manuals with applicable safety, warning and caution information from www.vacon.com/downloads.

REMARQUE Vous pouvez télécharger les versions anglaise et française des manuels produit contenant l'ensemble des informations de sécurité, avertissements et mises en garde applicables sur le site www.vacon.com/downloads.

FUNCTIONS OF THE VACON® AC DRIVE

- Wizards for startup, PID control, multipump and fire mode to make the commissioning easy.
- The Funct button for an easy change between the local and the remote control place. The remote control place can be I/O or fieldbus. You can make a selection of the remote control place with a parameter.
- Run interlock input (Damper interlock). Drive does not start before this input is activated.
- A control page to operate and monitor of the most important values quickly.
- Different pre-heat modes to prevent condensation problems.
- A maximum output frequency of 320 Hz.
- A Real time clock and timer functions (an optional battery is necessary). It is possible to program 3 time channels to get different functions on the drive.
- An external PID controller is available. You can use it, for example, to control a valve with the I/O of the AC drive.
- A sleep mode function that automatically enables and disables the operation of the drive to save energy.
- A 2-zone PID controller with 2 different feedback signals: minimum and maximum control.
- 2 setpoint sources for the PID control. You can make the selection with a digital input.
- A function for PID setpoint boost.
- A feedforward function to make the response to the process changes better.
- A process value supervision.
- A multipump control.
- A pressure loss compensation to compensate pressure losses in the pipework for example when the sensor is incorrectly placed near the pump or fan.

TABLE OF CONTENTS

Preface

About this manual	3
Functions of the Vacon® AC drive	5
1 Quick Startup Guide	10
1.1 Control panel and keypad	10
1.2 The displays	10
1.3 First start-up	11
1.4 Description of the applications	12
1.4.1 Vacon HVAC application	12
2 Wizards	19
2.1 PID mini-wizard	19
2.2 Multi-pump mini-wizard	20
2.3 Fire mode wizard	21
3 User interfaces	23
3.1 Navigation on the keypad	23
3.2 Using the graphical display	25
3.2.1 Editing the values	25
3.2.2 Resetting a fault	28
3.2.3 The Funct button	28
3.2.4 Copying the parameters	32
3.2.5 Comparing the parameters	34
3.2.6 Help texts	35
3.2.7 Using the Favourites menu	36
3.3 Using the text display	36
3.3.1 Editing the values	37
3.3.2 Resetting a fault	38
3.3.3 The Funct button	38
3.4 Menu structure	41
3.4.1 Quick setup	42
3.4.2 Monitor	42
3.5 Vacon Live	43
4 Monitoring menu	45
4.1 Monitor group	45
4.1.1 Multimonitor	45
4.1.2 Basic	46
4.1.3 Timer functions monitoring	49
4.1.4 PID1 controller monitoring	50
4.1.5 PID2 controller monitoring	51
4.1.6 Multi-pump monitoring	51
4.1.7 Fieldbus process data monitoring	52
5 Parameters menu	54
5.1 Group 3.1: Motor settings	54
5.2 Group 3.2: Start/stop setup	59

5.3	Group 3.3: Control reference settings	61
5.4	Group 3.4: Ramp and brakes setup	65
5.5	Group 3.5: I/O configuration	67
5.6	Group 3.6: Fieldbus data mapping	77
5.7	Group 3.7: Prohibit frequencies	78
5.8	Group 3.8: Limit supervisions	79
5.9	Group 3.9: Protections	80
5.10	Group 3.10: Automatic reset	84
5.11	Group 3.11: Timer functions	86
5.12	Group 3.12: PID-controller 1	90
5.13	Group 3.13: PID-controller 2	98
5.14	Group 3.14: Multipump	102
5.15	Group 3.16: Fire mode	104
5.16	Group 3.17: Application settings	106
5.17	Group 3.18: kWh pulse output settings	106
6	Diagnostics menu	107
6.1	Active faults	107
6.2	Reset faults	107
6.3	Fault history	107
6.4	Total counters	108
6.5	Trip counters	109
6.6	Software info	110
7	I/O and hardware menu	111
7.1	Basic I/O	111
7.2	Option board slots	113
7.3	Real time clock	114
7.4	Power unit settings	114
7.5	Keypad	116
7.6	Fieldbus	116
8	User settings, favourites and user level menus	117
8.1	User settings	117
	8.1.1 Parameter backup	118
8.2	Favourites	119
	8.2.1 Adding an item to the Favourites	119
	8.2.2 Removing an item from the Favourites	120
8.3	User levels	121
	8.3.1 Changing the access code of the user levels	121
9	Parameter descriptions	123
9.1	Motor settings	123
9.2	Start/Stop setup	125
9.3	References	132
9.4	Ramps and brakes setup	133

9.5	I/O configuration	134
9.5.1	Programming of digital and analogue inputs	134
9.5.2	Digital inputs	140
9.5.3	Analogue inputs	141
9.5.4	Digital outputs	143
9.6	Prohibit frequencies	144
9.7	Protections	145
9.7.1	Motor thermal protections	145
9.7.2	Motor stall protection	147
9.7.3	Underload (Dry pump) protection	148
9.8	Automatic reset	150
9.9	Timer functions	123
9.10	PID controller 1	154
9.10.1	Setpoints	154
9.10.2	Feedforward	155
9.10.3	Process supervision	156
9.10.4	Pressure loss compensation	157
9.11	PID controller 2	158
9.12	Multipump function	159
9.13	Fire mode	165
9.14	Application settings	166
10	Fault tracing	167
10.1	A fault comes into view	167
10.1.1	Resetting with the Reset button	167
10.1.2	Resetting with a parameter in the graphical display	167
10.1.3	Resetting with a parameter in the text display	168
10.2	Fault history	169
10.2.1	Examining the Fault history in the graphical display	169
10.2.2	Examining the Fault history in the text display	170
10.3	Fault codes	172

1 QUICK STARTUP GUIDE

1.1 CONTROL PANEL AND KEYPAD

The control panel is the interface between the AC drive and the user. With the control panel, you can control the speed of a motor and monitor the status of the AC drive. You can also set the parameters of the AC drive.

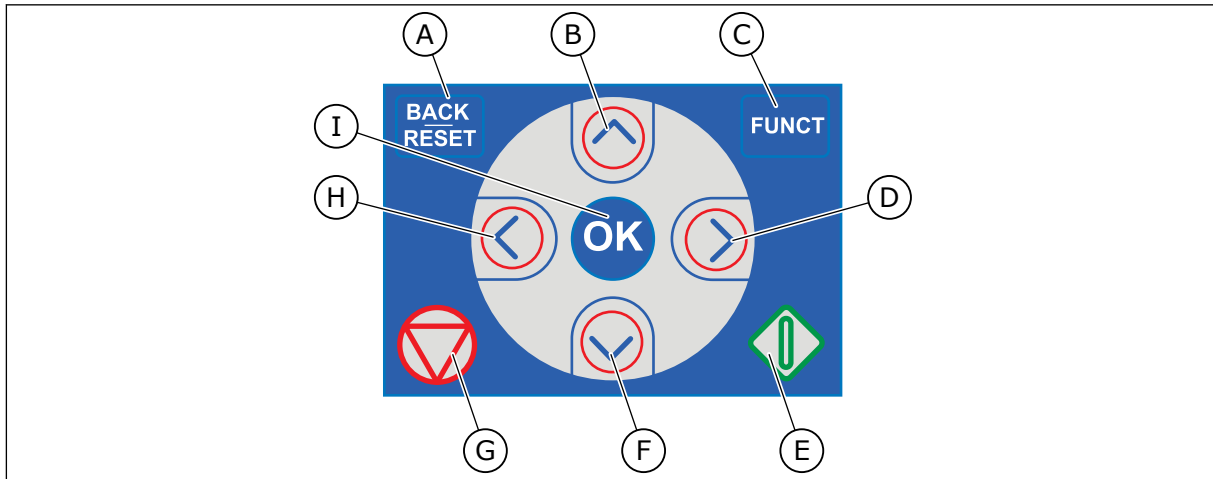

Fig. 1: The buttons of the keypad

- | | |
|--------------------------------------------------------------------------------------------------------------------------------------------------------------------------------------------------------------------------------------------------------------------------------------------------------------------------------------------------------------------------------------------|--------------------------------------------------------------------------------------------------------------------------------------------------------------------------------------------------------------------------------------------------------------------------------------------------------------------------------------------------|
| <p>A. The BACK/RESET button. Use it to move back in the menu, exit the Edit mode, reset a fault.</p> <p>B. The arrow button UP. Use it to scroll the menu up and to increase a value.</p> <p>C. The FUNCT button. Use it to change the rotation direction of the motor, access the control page, and change the control place. See more in <i>Table 12 Control reference settings</i>.</p> | <p>D. The arrow button RIGHT.</p> <p>E. The START button.</p> <p>F. The arrow button DOWN. Use it to scroll the menu down and to decrease a value.</p> <p>G. The STOP button.</p> <p>H. The arrow button LEFT. Use it to move the cursor left.</p> <p>I. The OK button. Use it to go into an active level or item, or to accept a selection.</p> |
|--------------------------------------------------------------------------------------------------------------------------------------------------------------------------------------------------------------------------------------------------------------------------------------------------------------------------------------------------------------------------------------------|--------------------------------------------------------------------------------------------------------------------------------------------------------------------------------------------------------------------------------------------------------------------------------------------------------------------------------------------------|

1.2 THE DISPLAYS

There are 2 display types: the graphical display and the text display. The control panel always has the same keypad and buttons.

The display shows this data.

- The status of the motor and the drive.
- Faults in the motor and in the drive.
- Your location in the menu structure.

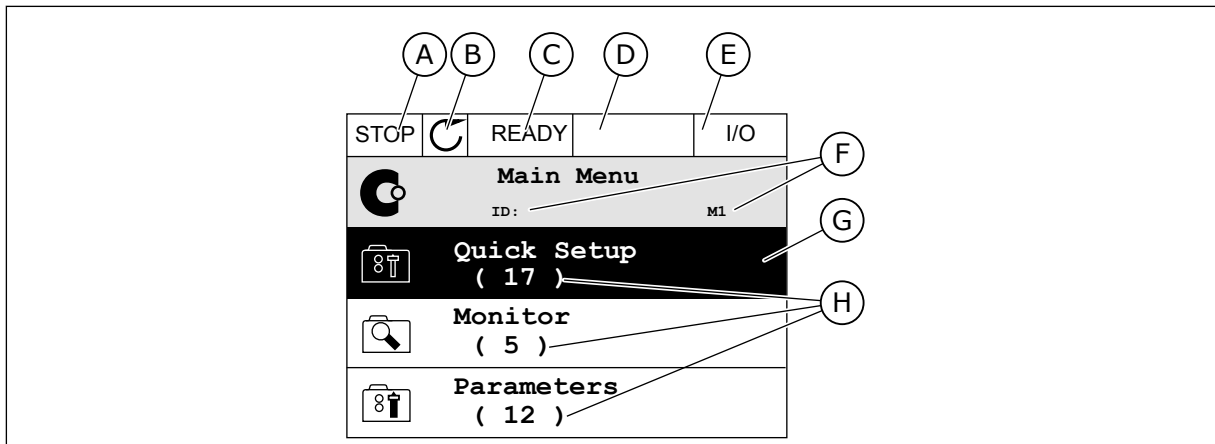

Fig. 2: The graphical display

- A. The first status field: STOP/RUN
- B. The rotation direction of the motor
- C. The second status field: READY/NOT READY/FAULT
- D. The alarm field: ALARM/-
- E. The control place field: PC/I/O/KEYPAD/ FIELDBUS
- F. The location field: the ID number of the parameter and the current location in the menu
- G. An activated group or item
- H. The number of items in the group in question

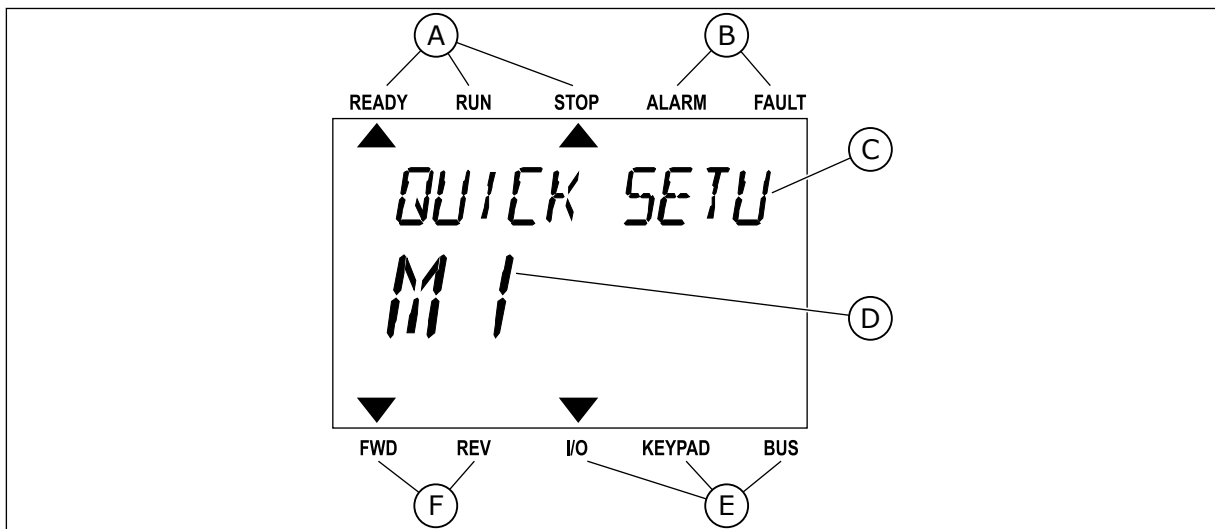

Fig. 3: The text display. If the text is too long to show, the text scrolls automatically on the display.

- A. The indicators of status
- B. The indicators of alarm and fault
- C. The name of the group or item of the current location
- D. The current location in the menu
- E. The indicators of the control place
- F. The indicators of the rotation direction

1.3 FIRST START-UP

The Start-up wizard tells you to give necessary data for the drive to control your procedure.

1	Language selection	The selection is different in all the language packages
2	Daylight saving*	Russia US EU OFF
3	Time*	hh:mm:ss
4	Date*	dd.mm.
5	Year*	yyyy

* If a battery is installed, you see these questions.

6	Run Startup wizard?	Yes No
---	---------------------	-----------

To set the parameter values manually, make the selection *No* and push the OK button.

7	Make a selection of a process	Pump Fan
8	Set a value for Motor Nominal Speed (so that it agrees with the nameplate)	Range: 24-19200
9	Set a value for Motor Nominal Current	Range: Varies
10	Set a value for Minimum frequency	Range: 0.00-50.00
11	Set a value for Maximum frequency	Range: 0.00-320.00

After these selections, the Start-up wizard is completed. To start the Start-up wizard again, you have 2 alternatives. Go to the parameter P6.5.1 Restore Factory Defaults or to the parameter P1.19 Start-up Wizard. Then set the value to *Activate*.

1.4 DESCRIPTION OF THE APPLICATIONS

1.4.1 VACON HVAC APPLICATION

The Vacon HVAC drive contains a preloaded application for instant use.

It is possible to control the drive from the keypad, Fieldbus, PC or I/O terminal.

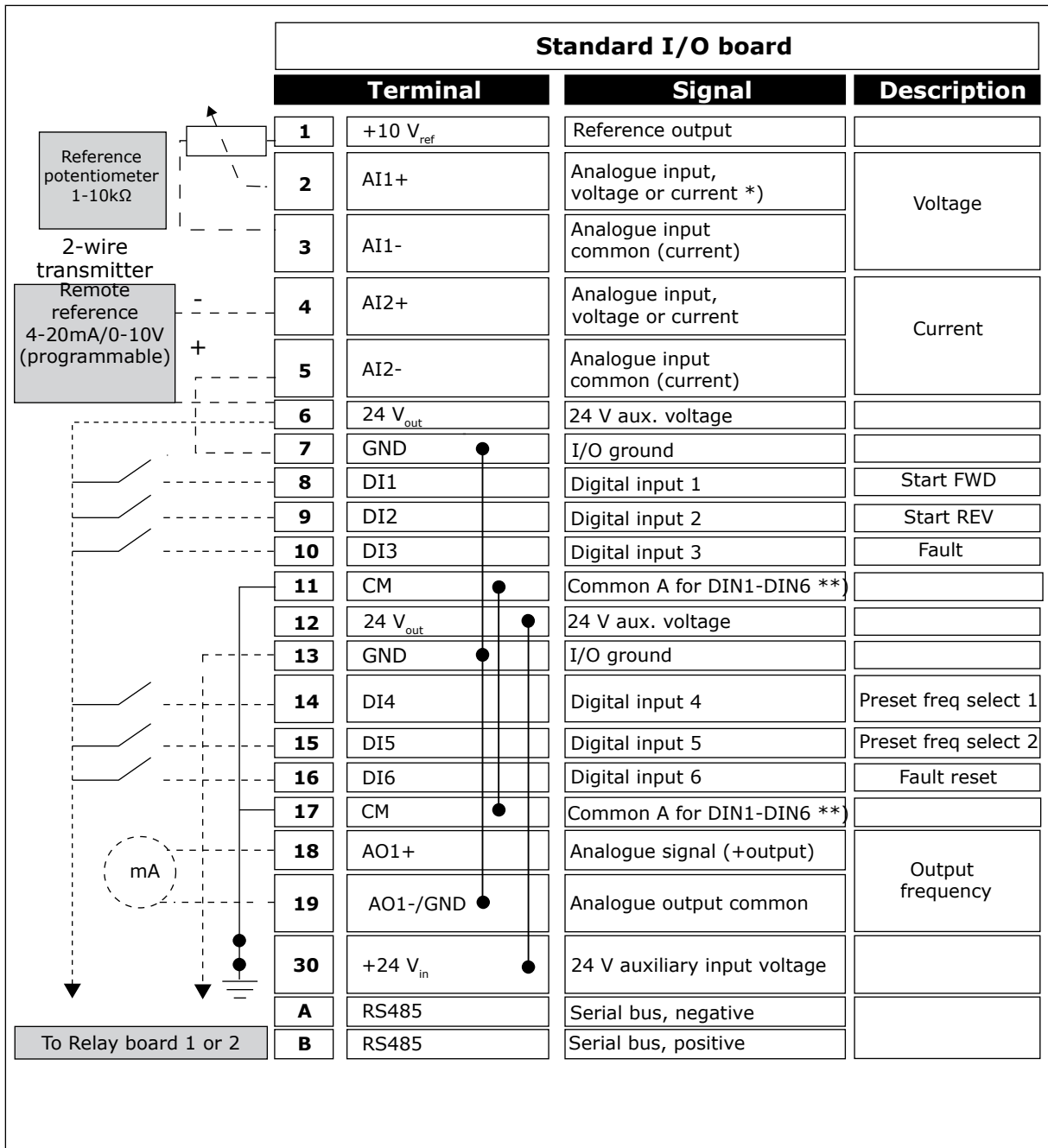

Fig. 4: The control connections example for the standard I/O board

* = You can use DIP switches to select these. See Vacon 100 Installation Manual, Wall-mounted Drives.

** = You can isolate the digital inputs from the ground with a DIP switch.

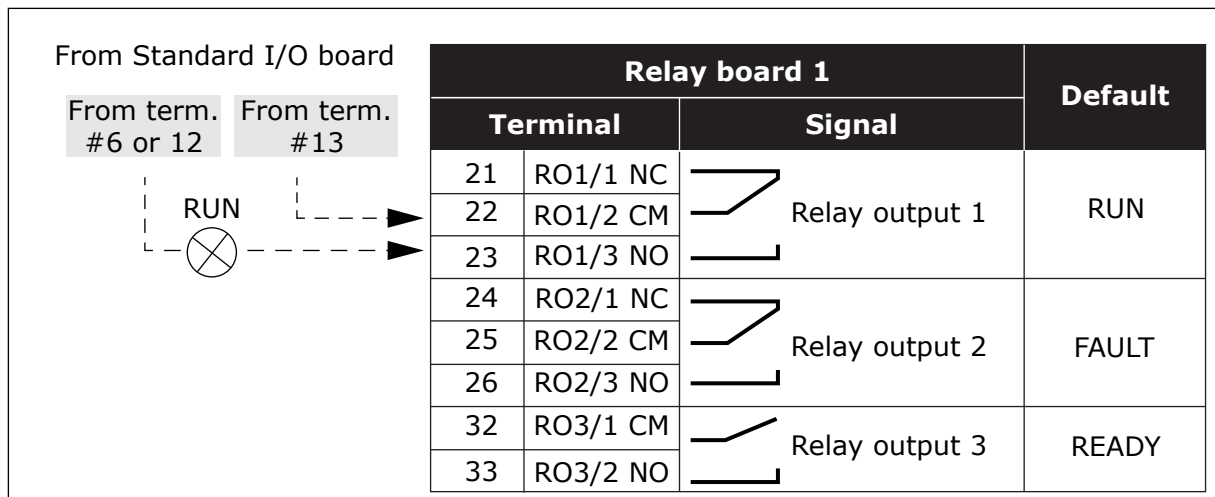

Fig. 5: The control connection example for the relay board 1



NOTE!

Not available for Vacon 100 X.

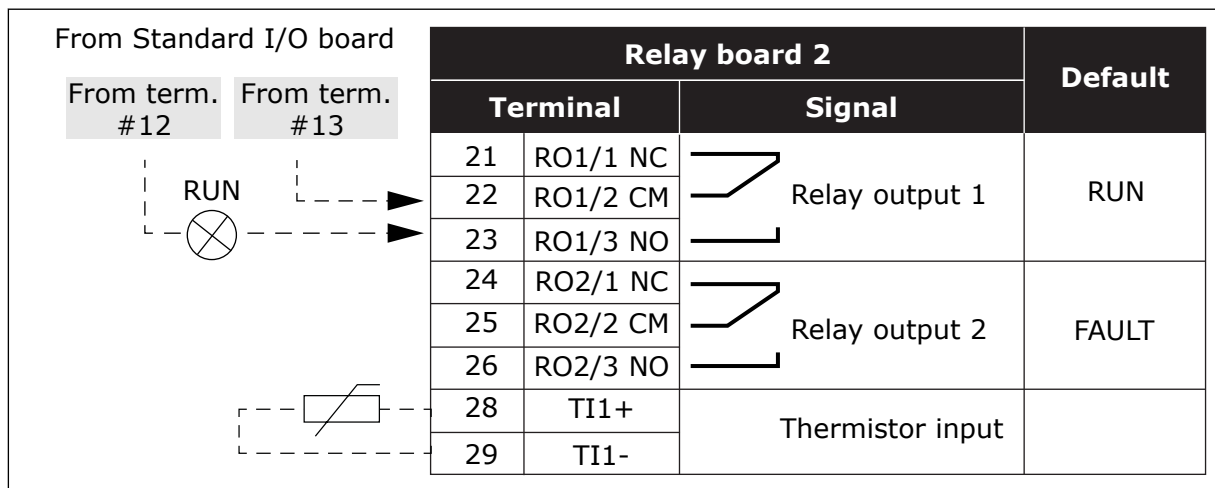

Fig. 6: The control connection example for the relay board 2



NOTE!

The only option for Vacon 100 X.

You can also isolate the digital inputs (terminals 8-10 and 14-16) on the standard I/O board from ground. To do this, set the dip switch on the control board to position OFF. See the figure below to find the switches and to make applicable selections for your requirements.



NOTE!

For the DIP switch configurations in Vacon 100 X, see the Vacon 100 X Installation manual.

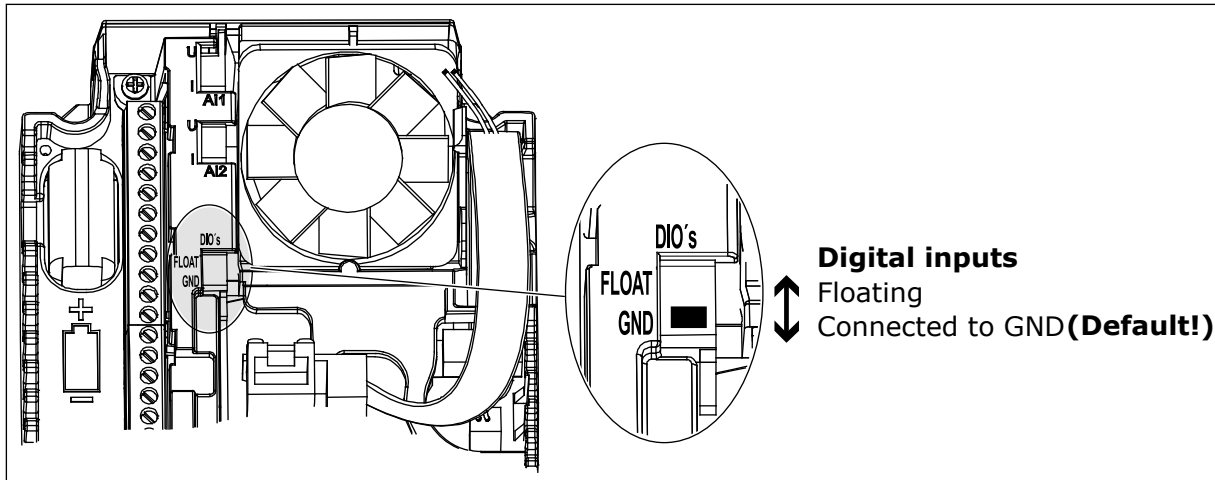

Fig. 7: The DIP switch

Table 2: Quick Setup parameter group

Index	Parameter	Min	Max	Unit	Default	ID	Description
P1.1	Motor Nominal Voltage	Varies	Varies	V	Varies	110	Find this value U_n on the nameplate of the motor. See P3.1.1.1.
P1.2	Motor Nominal Frequency	8.0	320.0	Hz	50	111	Find this value f_n on the nameplate of the motor. See P3.1.1.2.
P1.3	Motor Nominal Speed	24	19200	rpm	Varies	112	Find this value n_n on the nameplate of the motor.
P1.4	Motor Nominal Current	Varies	Varies	A	Varies	113	Find this value I_n on the nameplate of the motor.
P1.5	Motor Cos Phi	0.30	1.00		Varies	120	Find this value on the nameplate of the motor.
P1.6	Motor nominal power	Varies	Varies	kW	Varies	116	Find this value n_n on the nameplate of the motor.
P1.7	Motor Current Limit	Varies	Varies	A	Varies	107	The maximum motor current from the AC drive.
P1.8	Minimum Frequency	0.00	P1.9	Hz	Varies	101	The minimum frequency reference that is acceptable.
P1.9	Maximum Frequency	P1.8	320.00	Hz	50.00	102	The maximum frequency reference that is acceptable.
P1.10	I/O Control Reference A Selection	1	8		6	117	The selection of the frequency reference source when the control place is I/O A. See P3.3.3 for selections.
P1.11	Preset frequency 1	P3.3.1	300.00	Hz	10.00	105	Select with the digital input: Preset frequency selection 0 (P3.5.1.15) (Default = Digital Input 4)
P1.12	Preset frequency 2	P3.3.1	300.00	Hz	15.00	106	Select with the digital input: Preset frequency selection 1 (P3.5.1.16) (Default = Digital Input 5)

Table 2: Quick Setup parameter group

Index	Parameter	Min	Max	Unit	Default	ID	Description
P1.13	Acceleration Time 1	0.1	3000.0	s	20.0	103	Gives the quantity of time that is necessary for the output frequency to increase from zero frequency to the maximum frequency.
P1.14	Deceleration Time 1	0.1	3000.0	s	20.0	104	Gives the quantity of time that is necessary for the output frequency to decrease from the maximum frequency to zero frequency.
P1.15	Remote Control Place	1	2		1	172	The selection of the remote control place (start/stop). 0 = I/O control 1 = Fieldbus control
P1.16	Automatic Reset	0	1		0	731	0 = Disabled 1 = Enabled
P1.17	Thermistor Fault	0	3		0	732	0 = No action 1 = Alarm 2 = Fault (Stop according to stop mode) 3 = Fault (Stop by coasting)
P1.18	PID Mini-Wizard *	0	1		0	1803	0 = Inactive 1 = Activate See
P1.19	Multi-pump Wizard *	0	1		0		0 = Inactive 1 = Activate See Chapter 2.2 <i>Multi-pump mini-wizard</i> .

Table 2: Quick Setup parameter group

Index	Parameter	Min	Max	Unit	Default	ID	Description
P1.20	Startup Wizard **	0	1		0	1171	0 = Inactive 1 = Activate See Chapter 1.3 First start-up.
P1.21	Fire Mode Wizard **	0	1		0	1672	0 = Inactive 1 = Activate

* = The parameter is only visible on the graphical keypad.

** = The parameter is only visible on the graphical and the text keypad.

2 WIZARDS

2.1 PID MINI-WIZARD

The application wizard helps you to set the basic parameters that are related to the application.

To start the PID mini-wizard, set the value *Activate* to parameter P1.17 PID Mini-Wizard in the Quick Setup menu.

The default settings tell you to use the PID controller in the one feedback / one setpoint mode. The default control place is I/O A, and the default process unit is %.

1	Make selections for Process unit (P3.12.1.4)	More than 1 selection.
----------	----------------------------------------------	------------------------

If your selection is other than %, you see the next questions. If your selection is %, the wizard goes directly to question 5.

2	Set a value for Process Unit Min (P3.12.1.5)	The range depends on the selection in question 1.
3	Set a value for Process Unit Max (P3.12.1.6)	The range depends on the selection in question 1.
4	Set a value for Process Unit Decimals (P3.12.1.7)	Range: 0-4
5	Set a value for Feedback 1 Source Selection (P3.12.3.3)	See <i>Table 34 Feedback settings</i> .

If you make a selection of an analogue input signal, you see the question 6. With other selections, the wizard goes to question 7.

6	Set the signal range of the analogue input	0 = 0-10V / 0...20mA 1 = 2-10V / 4...20mA See <i>Table 15 Analogue input settings</i> .
7	Set a value for Error Inversion (P3.12.1.8)	0 = Normal 1 = Inverted
8	Set a value for Setpoint Source Selection (P3.12.2.4)	See <i>Table 33 Setpoint settings</i> .

If you make a selection of an analogue input signal, you see the question 9. With other selections, the wizard goes to question 11.

If you set *Keypad Setpoint 1* or *Keypad Setpoint 2* for the value, the wizard goes directly to question 10.

9	Set the signal range of the analogue input	0 = 0-10V / 0-20mA 1 = 2-10V / 4-20mA See Table 15 Analogue input settings.
10	Set a value for Keypad Setpoint 1 (P3.12.2.1) and Keypad Setpoint 2 (P3.12.2.2)	Depends on the range set in the question 9.
11	Using the sleep function	0 = No 1 = Yes

If you give the value *Yes* for the question 11, you see the next 3 questions. If you give the value *No*, the wizard is completed.

12	Set a value for Sleep Frequency Limit (P3.12.2.7)	Range: 0.00-320.00 Hz
13	Set a value for Sleep Delay 1 (P3.12.2.8)	Range: 0-3000 s
14	Set a value for Wake-up Level (P3.12.2.9)	The range depends on the set process unit

The PID mini-wizard is completed.

2.2 MULTI-PUMP MINI-WIZARD

The Multi-pump mini-wizard asks the most important questions to set up a Multi-pump system. The Multi-pump mini-wizard always follows the PID mini-wizard.

15	Set a value for Number of Motors (P.3.14.1)	1-4
16	Set a value for Interlock Function (P3.14.2)	0 = Not used 1 = Enabled
17	Set a value for Autochange (P3.14.4)	0 = Disabled 1 = Enabled

If you enable the Autochange function, you see the next 3 questions. If you do not use the Autochange function, the wizard goes directly to question 21.

18	Set a value for Include FC (P3.14.3)	0 = Disabled 1 = Enabled
19	Set a value for Autochange Interval (P3.14.5)	0.0-3000.0 h
20	Set a value for Autochange: Frequency Limit (P3.14.6)	0.00-50.00 Hz
21	Set a value for Bandwidth (P3.14.8)	0-100%
22	Set a value for Bandwidth Delay (P3.14.9)	0-3600 s

After this, the keypad shows the digital input and relay output configuration done by the application (graphical keypad only). Write these values down for future reference.

2.3 FIRE MODE WIZARD

To start the Fire Mode Wizard, make the selection *Activate* for parameter B1.1.4 in the Quick setup menu.



CAUTION!

Before you continue, read about the password and warranty in Chapter 9.13 *Fire mode*.

1	Set a value for parameter P3.17.2 Fire Mode Frequency Source	More than 1 selection
---	--------------------------------------------------------------	-----------------------

If you set a value other than *Fire mode frequency*, the wizard goes directly to question 3.

2	Set a value for parameter P3.17.3 Fire Mode Frequency	8.00 Hz...P3.3.1.2 (MaxFreqRef)
3	Activate the signal when the contact opens or when it closes	0 = Open contact 1 = Closed contact
4	Set a value for parameters P3.17.4 Fire Mode Activation on OPEN / P3.17.5 Fire Mode Activation on CLOSE	Make a selection of a digital input to activate Fire mode. See also Chapter 9.13 <i>Fire mode</i> .
5	Set a value for parameter P3.17.6 Fire Mode Reverse	Make a selection of a digital input to activate the reverse direction in Fire mode. DigIn Slot0.1 = FORWARD DigIn Slot0.2 = REVERSE
6	Set a value for P3.17.1 Fire Mode Password	Set a password to enable the Fire mode function. 1234 = Enable test mode 1001 = Enable Fire mode

3 USER INTERFACES

3.1 NAVIGATION ON THE KEYPAD

The data of the AC drive is in menus and submenus. To move between the menus, use the arrow buttons Up and Down in the keypad. To go into a group or an item, push the OK button. To go back to the level where you were before, push the Back/Reset button.

On the display, you see your current location in the menu, for example M5.5.1. You also see the name of the group or item in your current location.

3.2 USING THE GRAPHICAL DISPLAY

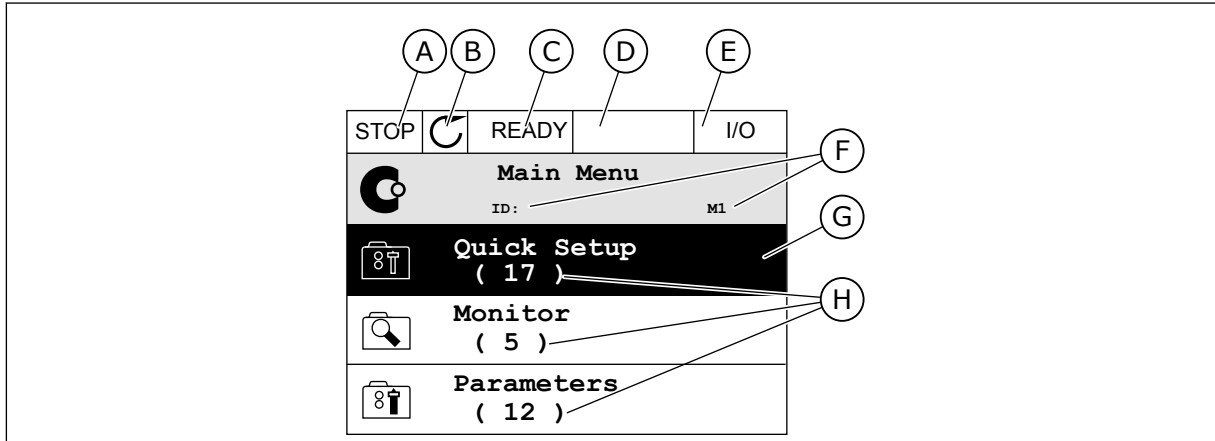

Fig. 9: The main menu of the graphical display

- A. The first status field: STOP/RUN
- B. The rotation direction
- C. The second status field: READY/NOT READY/FAULT
- D. The alarm field: ALARM/-
- E. The control place: PC/I/O/KEYPAD/FIELDBUS
- F. The location field: the parameter ID number and the current location in the menu
- G. An activated group or item: push OK to go in
- H. The number of items in the group in question

3.2.1 EDITING THE VALUES

On the graphical display, there are 2 different procedures to edit the value of an item.

Usually, you can set only 1 value for a parameter. Select from a list of text values or from a range of numerical values.

CHANGING THE TEXT VALUE OF A PARAMETER

- 1 Find the parameter with the arrow buttons.

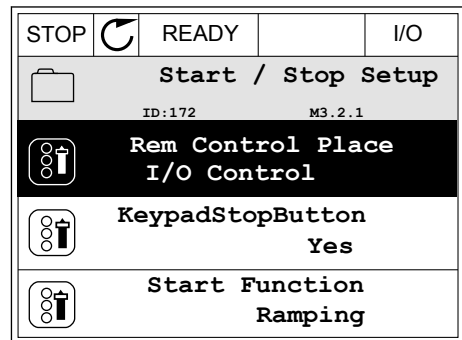

- To go to the Edit mode, push the OK button 2 times or push the arrow button Right.

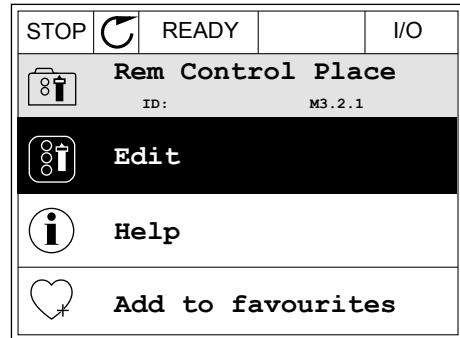

- To set a new value, push the arrow buttons Up and Down.

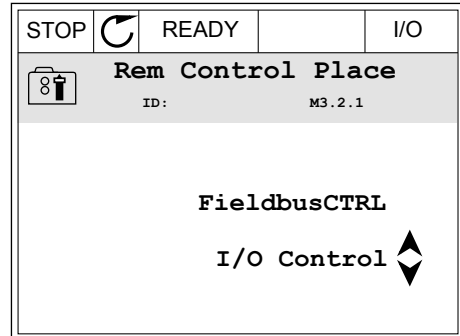

- To accept the change, push the OK button. To ignore the change, use the Back/Reset button.

EDITING THE NUMERICAL VALUES

- Find the parameter with the arrow buttons.

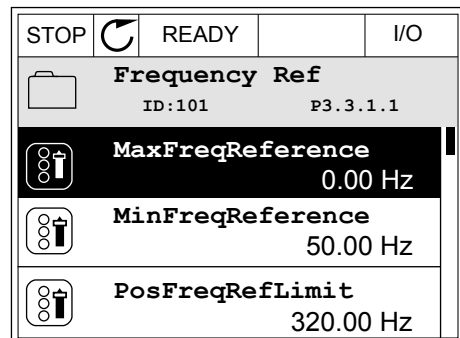

- Go to the Edit mode.

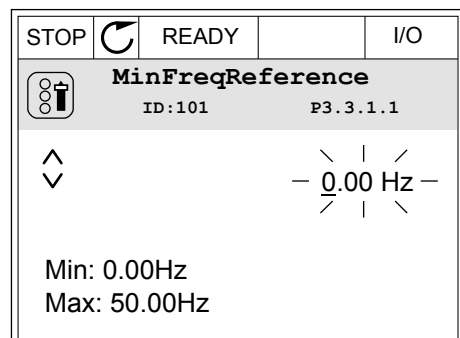

- 3 If the value is numerical, move from digit to digit with the arrow buttons Left and Right. Change the digits with the arrow buttons Up and Down.

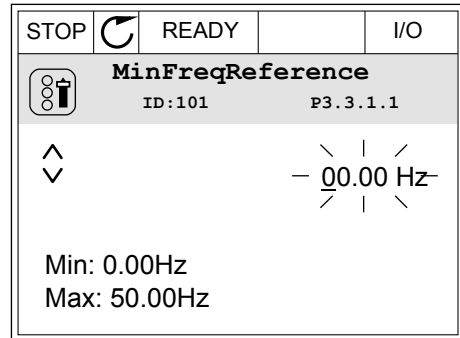

- 4 To accept the change, push the OK button. To ignore the change, go back to the level where you were before with the Back/Reset button.

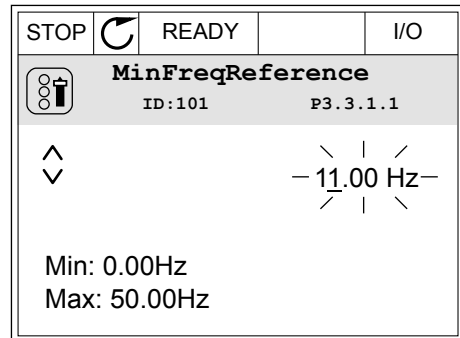

THE SELECTION OF MORE THAN 1 VALUE

Some parameters let you to make a selection of more than 1 value. Select a checkbox at each necessary value.

- 1 Find the parameter. There is a symbol on the display when a checkbox selection is possible.

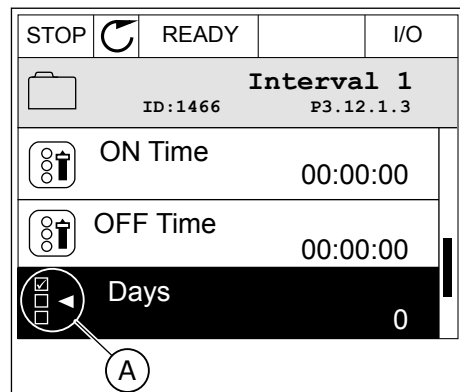

- A. The symbol of the checkbox selection

- 2 To move in the list of values, use the arrow buttons Up and Down.

STOP		READY		I/O
Days				
ID: M 3.12.1.3.1				
<input type="checkbox"/>	Sunday			
<input type="checkbox"/>	Monday			
<input type="checkbox"/>	Tuesday			
<input type="checkbox"/>	Wednesday			
<input type="checkbox"/>	Thursday			
<input type="checkbox"/>	Friday			

- 3 To add a value into your selection, select the box that is next to it with the arrow button Right.

STOP		READY		I/O
Days				
ID: M 3.12.1.3.1				
<input checked="" type="checkbox"/>	Sunday			
<input type="checkbox"/>	Monday			
<input type="checkbox"/>	Tuesday			
<input type="checkbox"/>	Wednesday			
<input type="checkbox"/>	Thursday			
<input type="checkbox"/>	Friday			

3.2.2 RESETTING A FAULT

To reset a fault, you can use the Reset button or the parameter Reset Faults. See the instructions in *10.1 A fault comes into view*.

3.2.3 THE FUNCT BUTTON

You can use the Funct button for 3 functions.

- To have an access to the Control page.
- To easily change between the Local and Remote control places.
- To change the rotation direction.

The selection of the control place determines from where the AC drive takes the start and stop commands. All the control places have a parameter for the selection of the frequency reference source. The Local control place is always the keypad. The Remote control place is I/O or Fieldbus. You can see the current control place on the status bar of the display.

It is possible to use I/O A, I/O B and Fieldbus as Remote control places. I/O A and Fieldbus have the lowest priority. You can make a selection of them with P3.2.1 (Remote Control Place). I/O B can bypass the Remote control places I/O A and Fieldbus with a digital input. You can make a selection of the digital input with parameter P3.5.1.5 (I/O B Control Force).

The keypad is always used as a control place when the control place is Local. Local control has higher priority than Remote control. For example, when you are in Remote control, if parameter P3.5.1.5 bypasses the control place with a digital input, and you make a selection of Local, Keypad becomes the control place. Use the Funct button or P3.2.2 Local/Remote to change between the Local and Remote control.

CHANGING THE CONTROL PLACE

1 Anywhere in the menu structure, push the Funct button.

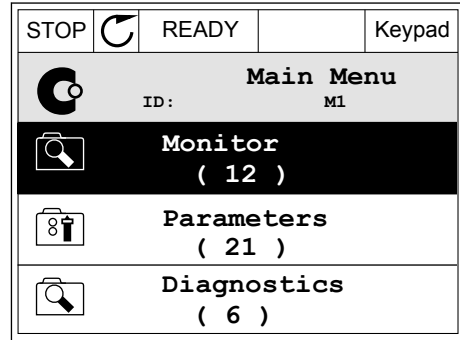

2 To make a selection of the Local/Remote, use the arrow buttons Up and Down. Push the OK button.

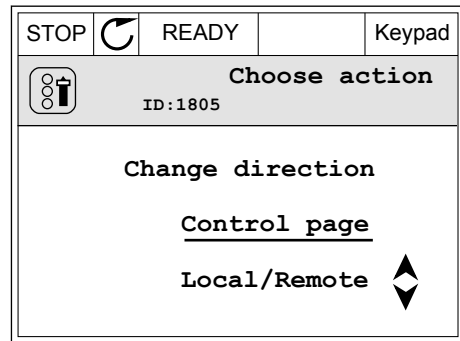

3 To make a selection of Local or Remote, use the arrow buttons Up and Down again. To accept the selection, push the OK button.

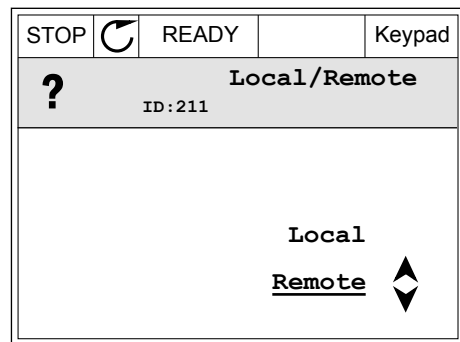

4 If you changed Remote control place to Local, that is, the keypad, give a keypad reference.

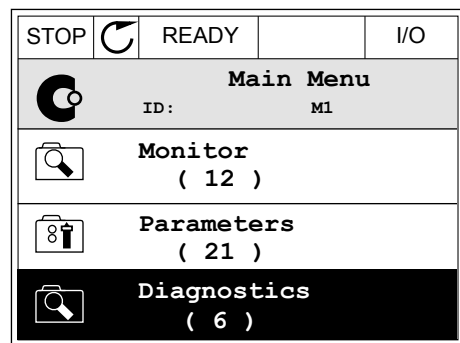

After the selection, the display goes back into the same location where it was when you pushed the Funct button.

GOING INTO THE CONTROL PAGE

It is easy to monitor the most important values in the Control page.

- 1 Anywhere in the menu structure, push the Funct button.

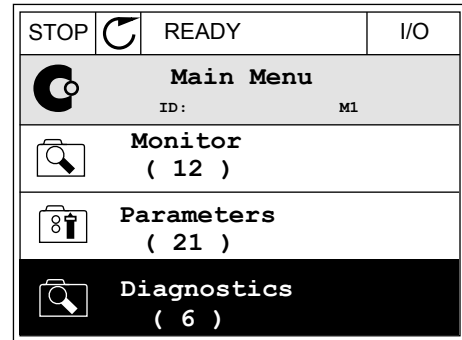

- 2 To make a selection of the Control page, push the arrow buttons Up and Down. Go in with the OK button. The control page opens.

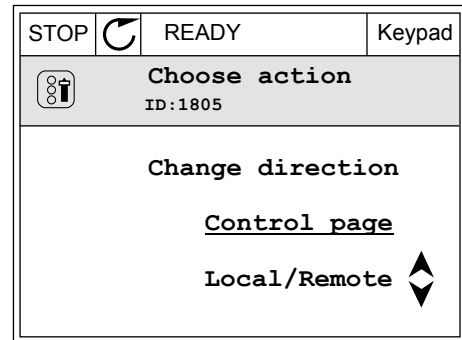

- 3 If you use the Local control place and the keypad reference, you can set P3.3.6 Keypad Reference with the OK button.

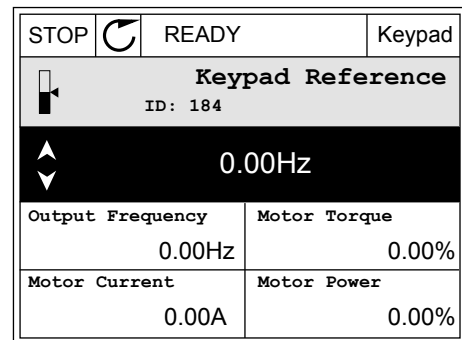

- 4 To change the digits in the value, push the arrow buttons Up and Down. Accept the change with the OK button.

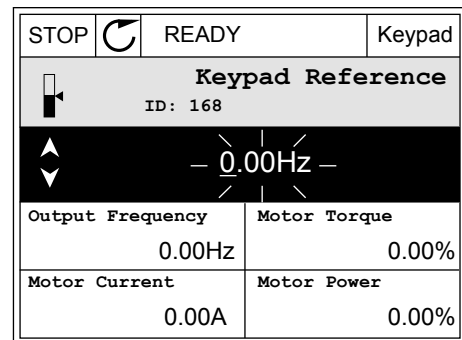

See more information about Keypad Reference in Chapter 5.3 Group 3.3: Control reference settings. If you use other control places or reference values, the display shows the frequency reference, which you cannot edit. The other values on the page are Multimonitoring values.

You can make a selection of the values that show up here (see instructions in Chapter 4.1.1 *Multimonitor*).

CHANGING THE ROTATION DIRECTION

You can change the rotation direction of the motor quickly with the Funct button.



NOTE!

The command Change direction is available in the menu only if the current control place is Local.

- 1 Anywhere in the menu structure, push the Funct button.

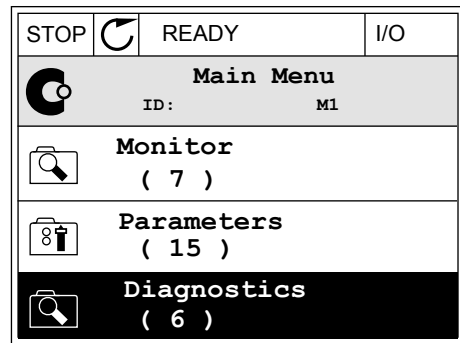

- 2 To make a selection of the Change direction, push the arrow buttons Up and Down. Push the OK button.

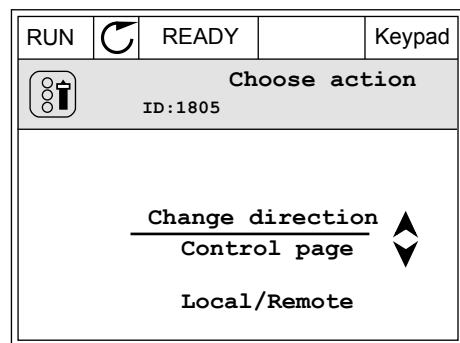

- 3 Make a selection of a new rotation direction. The current rotation direction blinks. Push the OK button.

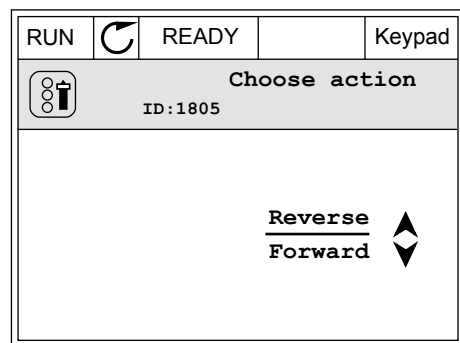

- 4 The rotation direction changes immediately. You can see that the arrow indication in the status field of the display changes.

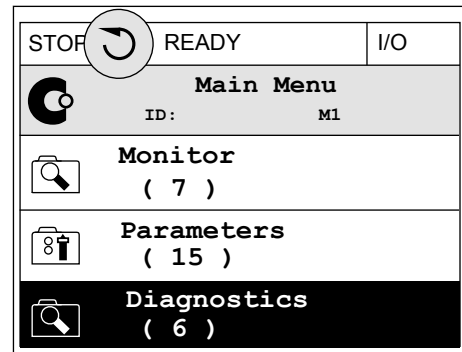

3.2.4 COPYING THE PARAMETERS



NOTE!

This function is available only in the graphical display.

Before you can copy parameters from the control panel to the drive, you must stop the drive.

COPYING THE PARAMETERS OF AN AC DRIVE

Use this function to copy parameters from a drive to another.

- 1 Save the parameters to the control panel.
- 2 Detach the control panel and connect it to another drive.
- 3 Download the parameters to the new drive with the command Restore from keypad.

SAVING THE PARAMETERS TO THE CONTROL PANEL

- 1 Go into the User settings menu.

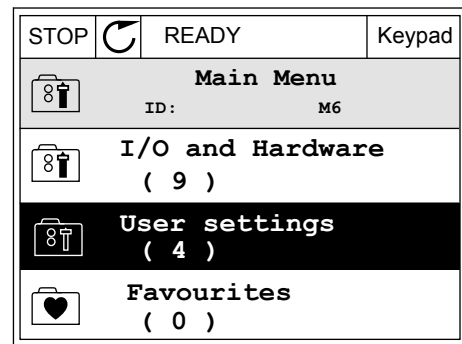

- 2 Go into the Parameter backup submenu.

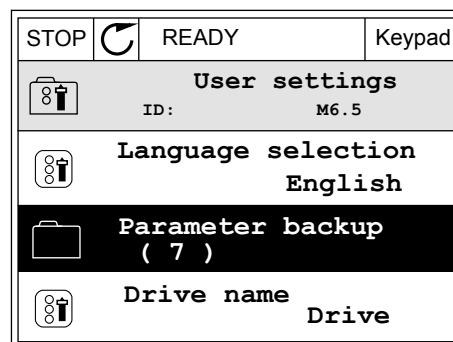

- 3 Use the arrow buttons Up and Down to make a selection of a function. Accept the selection with the OK button.

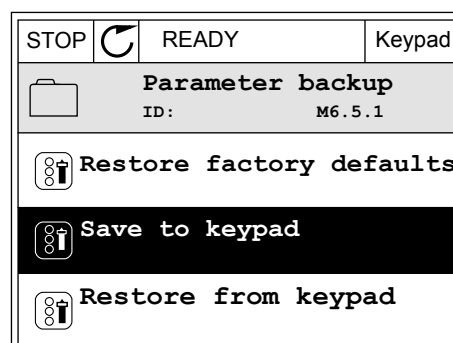

The command Restore factory defaults brings back the parameter settings that were made at the factory. With the command Save to keypad you can copy all the parameters to the control panel. The command Restore from keypad copies all the parameters from the control panel to the drive.

The parameters that you cannot copy if the drives have a different size

If you replace the control panel of a drive with a control panel from a drive that is of a different size, the values of these parameters do not change.

- Motor nominal voltage (P3.1.1.1)
- Motor nominal frequency (P3.1.1.2)
- Motor nominal speed (P3.1.1.3)
- Motor nominal current (P3.1.1.4)
- Motor cos phii (P3.1.1.5)
- Motor nominal power (P3.1.1.6)
- Motor current limit (P3.1.1.7)
- Switching frequency (P3.1.2.1)
- Zero frequency voltage (P3.1.2.4)
- Motor preheat current (P3.1.2.7)
- Stator voltage adjust (P3.1.2.17)
- Maximum frequency (P3.3.2)
- Start magnetizing current (P3.4.8)
- DC brake current (P3.4.10)
- Flux braking current (P3.4.13)
- Stall current limit (P3.9.5)
- Motor thermal time constant (P3.9.9)

3.2.5 COMPARING THE PARAMETERS

With this function, you can compare the current parameter set with 1 of these 4 sets.

- Set 1 (P6.5.4 Save to Set 1)
- Set 2 (P6.5.6 Save to Set 2)
- The defaults (P6.5.1 Restore Factory Defaults)
- The keypad set (P6.5.2 Save to Keypad)

See more about these parameters in *Table 57 The parameter compare*.



NOTE!

If you have not saved the parameter set with which you want to compare the current set, the display shows the text *Comparing failed*.

USING THE FUNCTION PARAMETER COMPARE

- 1 Go into Parameter Compare in the User settings menu.
- 2 Make a selection of the pair of sets. Push OK to accept the selection.
- 3 Make a selection of Active and push OK.

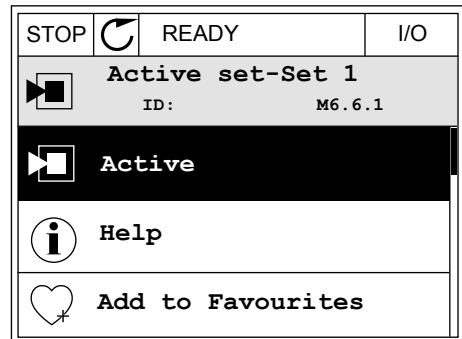
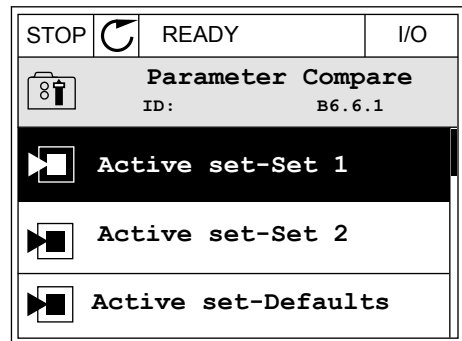
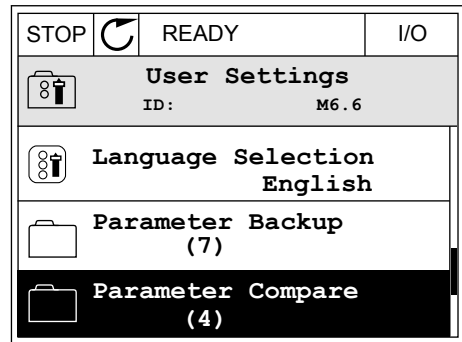

- Examine the comparing between the current values and the values of the other set.

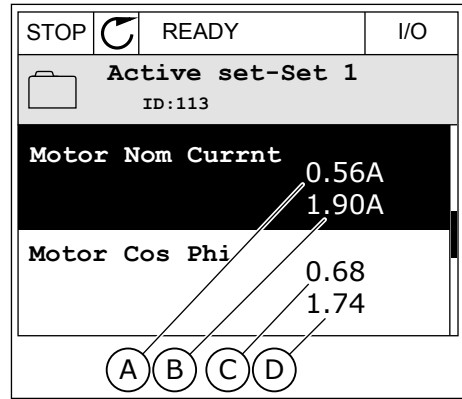

- The current value
- The value of the other set
- The current value
- The value of the other set

3.2.6 HELP TEXTS

The graphical display can show help texts on many topics. All the parameters have a help text.

The help texts are also available for the faults, alarms, and the Startup wizard.

READING A HELP TEXT

- Find the item about which you want to read.

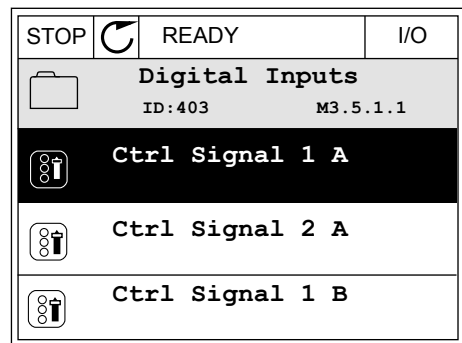

- Use the arrow buttons Up and Down to make a selection of Help.

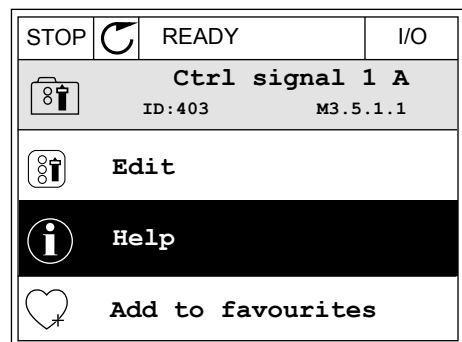

3 To open the help text, push the OK button.

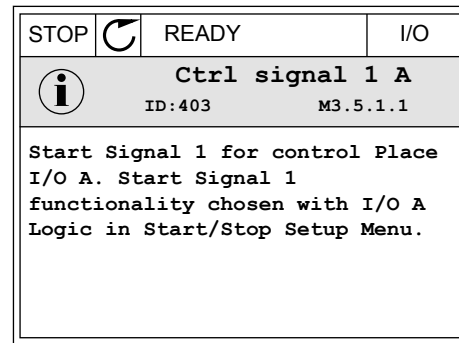

NOTE!

The help texts are always in English.

3.2.7 USING THE FAVOURITES MENU

If you use the same items frequently, you can add them into Favourites. You can collect a set of parameters or monitoring signals from all the keypad menus.

See more about how to use the Favourites menu in Chapter 8.2 *Favourites*.

3.3 USING THE TEXT DISPLAY

You can also have the control panel with the text display for your user interface. The text display and the graphical display have almost the same functions. Some functions are only available in the graphical display.

The display shows the status of the motor and the AC drive. It also shows faults in the operation of the motor and the drive. On the display, you see your current location in the menu. You also see the name of the group or item in your current location. If the text is too long for the display, the text scrolls to show the full text string.

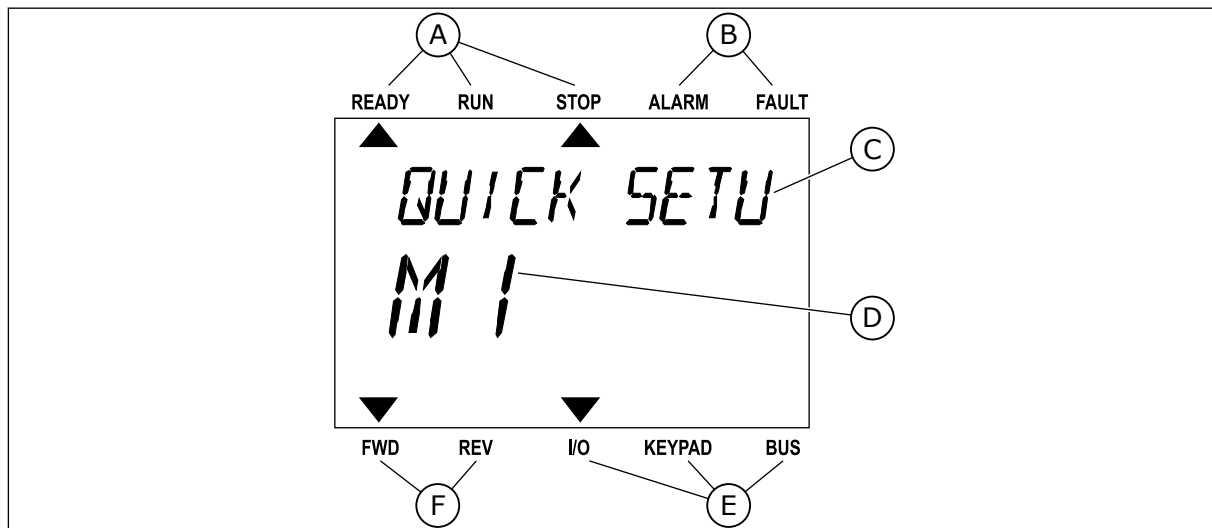

Fig. 10: The main menu of the text display

- A. The indicators of status
- B. The indicators of alarm and fault
- C. The name of the group or item of the current location

- D. The current location in the menu
- E. The indicators of the control place
- F. The indicators of the rotation direction

3.3.1 EDITING THE VALUES

CHANGING THE TEXT VALUE OF A PARAMETER

Set the value of a parameter with this procedure.

- 1 Find the parameter with the arrow buttons.



- 2 To go to the Edit mode, push the OK button.

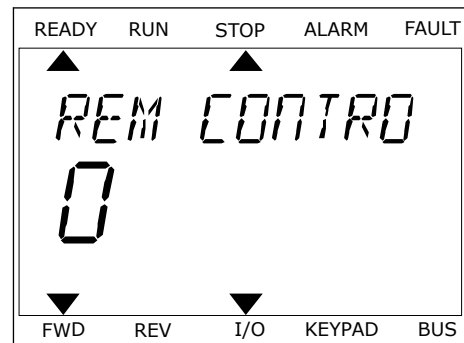

- 3 To set a new value, push the arrow buttons Up and Down.

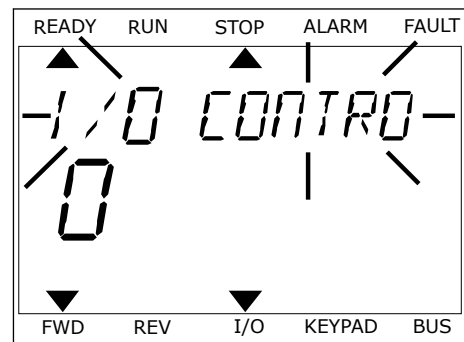

- 4 Accept the change with the OK button. To ignore the change, go back to the level where you were before with the Back/Reset button.

EDITING THE NUMERICAL VALUES

- 1 Find the parameter with the arrow buttons.
- 2 Go to the Edit mode.

- 3 Move from digit to digit with the arrow buttons Left and Right. Change the digits with the arrow buttons Up and Down.
- 4 Accept the change with the OK button. To ignore the change, go back to the level where you were before with the Back/Reset button.

3.3.2 RESETTING A FAULT

To reset a fault, you can use the Reset button or the parameter Reset Faults. See the instructions in *10.1 A fault comes into view*.

3.3.3 THE FUNCT BUTTON

You can use the Funct button for 3 functions.

- To have an access to the Control page.
- To easily change between the Local and Remote control places.
- To change the rotation direction.

The selection of the control place determines from where the AC drive takes the start and stop commands. All the control places have a parameter for the selection of the frequency reference source. The Local control place is always the keypad. The Remote control place is I/O or Fieldbus. You can see the current control place on the status bar of the display.

It is possible to use I/O A, I/O B and Fieldbus as Remote control places. I/O A and Fieldbus have the lowest priority. You can make a selection of them with P3.2.1 (Remote Control Place). I/O B can bypass the Remote control places I/O A and Fieldbus with a digital input. You can make a selection of the digital input with parameter P3.5.1.5 (I/O B Control Force).

The keypad is always used as a control place when the control place is Local. Local control has higher priority than Remote control. For example, when you are in Remote control, if parameter P3.5.1.5 bypasses the control place with a digital input, and you make a selection of Local, Keypad becomes the control place. Use the Funct button or P3.2.2 Local/Remote to change between the Local and Remote control.

CHANGING THE CONTROL PLACE

- 1 Anywhere in the menu structure, push the Funct button.

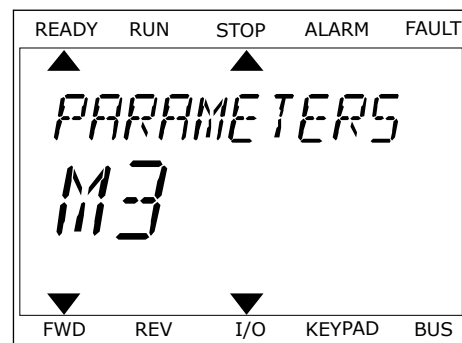

- 2 To make a selection of the Local/Remote, use the arrow buttons Up and Down. Push the OK button.



- 3 To make a selection of Local **or** Remote, use the arrow buttons Up and Down again. To accept the selection, push the OK button.

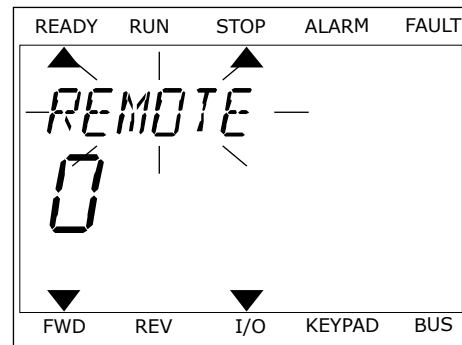

- 4 If you changed Remote control place to Local, that is, the keypad, give a keypad reference.

After the selection, the display goes back into the same location where it was when you pushed the Funct button.

GOING INTO THE CONTROL PAGE

It is easy to monitor the most important values in the Control page.

- 1 Anywhere in the menu structure, push the Funct button.

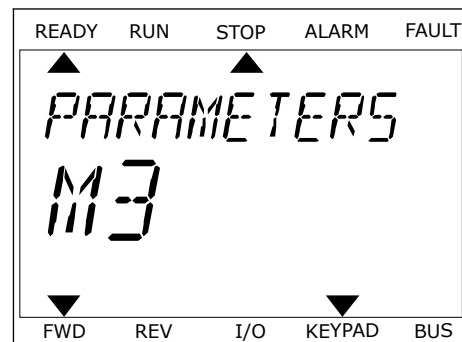

- 2 To make a selection of the Control page, push the arrow buttons Up and Down. Go in with the OK button. The control page opens.

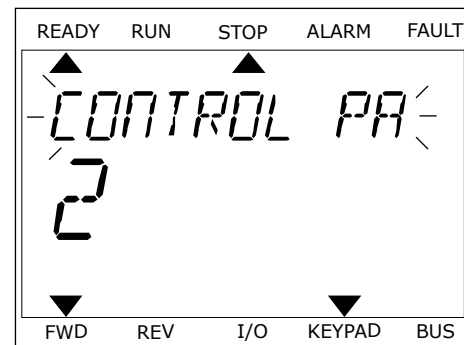

- 3 If you use the Local control place and the keypad reference, you can set P3.3.6 Keypad Reference with the OK button.

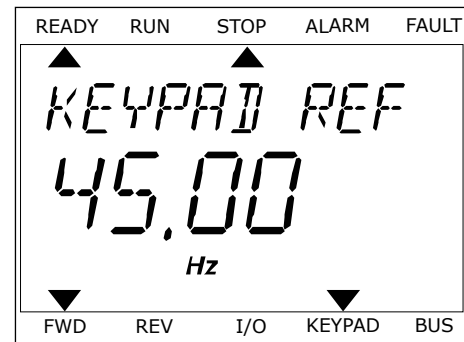

See more information about the Keypad Reference in Chapter 5.3 *Group 3.3: Control reference settings*). If you use other control places or reference values, the display shows the frequency reference, which you cannot edit. The other values on the page are Multimonitoring values. You can make a selection of the values that show up here (see instructions in Chapter 4.1.1 *Multimonitor*).

CHANGING THE ROTATION DIRECTION

You can change the rotation direction of the motor quickly with the Funct button.



NOTE!

The command Change direction is available in the menu only if the current control place is Local.

- 1 Anywhere in the menu structure, push the Funct button.
- 2 To make a selection of the Change direction, push the arrow buttons Up and Down. Push the OK button.
- 3 Make a selection of a new rotation direction. The current rotation direction blinks. Push the OK button. The rotation direction changes immediately, and the arrow indication in the status field of the display changes.

3.4 MENU STRUCTURE

Menu	Function
Quick setup	See Chapter 1.4.1 <i>Vacon HVAC application</i> .
Monitor	Multi-monitor *
	Basic
	Timer functions
	PID controller 1
	PID controller 2
	Multi-Pump
	Fieldbus data
	Temperature inputs **
Parameters	See Chapter 5 <i>Parameters menu</i> .
Diagnostics	Active faults
	Reset faults
	Fault history
	Total counters
	Trip counters
	Software info
I/O and hardware	Basic I/O
	Slot C
	Slot D
	Slot E
	Real time clock
	Power unit settings
	Keypad
	RS-485
	Ethernet

Menu	Function
User settings	Language selections
	Application selection
	Parameter backup *
	Drive name
Favourites *	See Chapter 8.2 <i>Favourites</i> .
User levels	See Chapter 8.3 <i>User levels</i> .

* = The function is not available in the control panel with a text display.

** = The function is only available when the OPT-88 or OPT-BH option board is connected to the AC drive.

3.4.1 QUICK SETUP

The Quick Setup Menu includes the minimum set of the most commonly used parameters during installation and commissioning of the Vacon 100 HVAC Application. They are collected in the first parameter group so that they are fast and easy to find. You can also find and edit them in their actual parameter groups. When you change a parameter value in the Quick setup group, also the value of this parameter in its actual group changes. More detailed information on the parameters of this group you will find in chapter 1.3 *First start-up* and 2 *Wizards*.

3.4.2 MONITOR

MULTIMONITOR

With the Multimonitor function, you can collect 4-9 items to monitor. See Chapter 4.1.1 *Multimonitor*.

**NOTE!**

The Multimonitor menu is not available in the text display.

BASIC

The basic monitoring values can include statuses, measurements, and the actual values of parameters and signals. See Chapter 4.1.2 *Basic*.

TIMER FUNCTIONS

With this function, you can monitor the timer functions and the Real Time Clock. See Chapter 4.1.3 *Timer functions monitoring*.

PID CONTROLLER 1

With this function, you can monitor the PID controller values. See Chapter 4.1.4 *PID1 controller monitoring*.

PID CONTROLLER 2

With this function, you can monitor the PID controller values. See Chapter 4.1.5 *PID2 controller monitoring*.

MULTI-PUMP

Use this function to monitor the values that are related to the operation of more than 1 drive. See Chapter 4.1.6 *Multi-pump monitoring*.

FIELDBUS DATA

With this function, you see the fieldbus data as monitor values. Use this function, for example, for monitoring during the fieldbus commissioning. See Chapter 4.1.7 *Fieldbus process data monitoring*.

3.5 VACON LIVE

Vacon Live is a PC tool for commissioning and maintenance of the Vacon® 10, Vacon® 20, and Vacon® 100 AC drives). You can download Vacon Live from www.vacon.com.

The Vacon Live PC tool includes these functions.

- Parametrisation, monitoring, drive info, data logger, etc.
- The software download tool Vacon Loader
- Serial communication and Ethernet support
- Windows XP, Vista 7 and 8 support
- 17 languages: English, German, Spanish, Finnish, French, Italian, Russian, Swedish, Chinese, Czech, Danish, Dutch, Polish, Portuguese, Romanian, Slovak and Turkish

You can make the connection between the AC drive and the PC tool with the Vacon serial communication cable. The serial communication drivers are installed automatically during the installation of Vacon Live. After you installed the cable, Vacon Live finds the connected drive automatically.

See more on how to use Vacon Live in the help menu of the program.

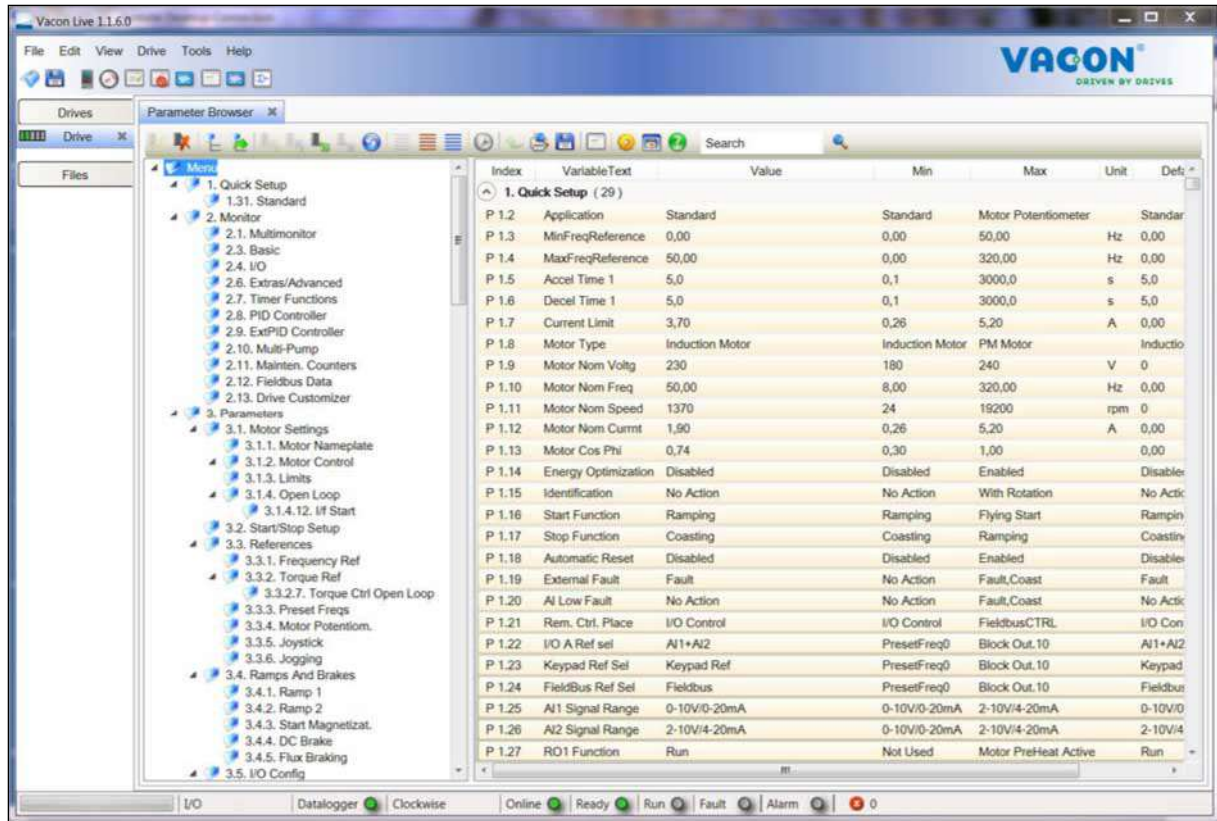

Fig. 11: The Vacon Live PC tool

4 MONITORING MENU

4.1 MONITOR GROUP

You can monitor the actual values of the parameters and signals. You can also monitor the statuses and measurements. You can customise some of the values that you can monitor.

4.1.1 MULTIMONITOR

On the Multimonitor page, you can collect 9 items to monitor.

CHANGING THE ITEMS TO MONITOR

1 Go into the Monitor menu with the OK button.

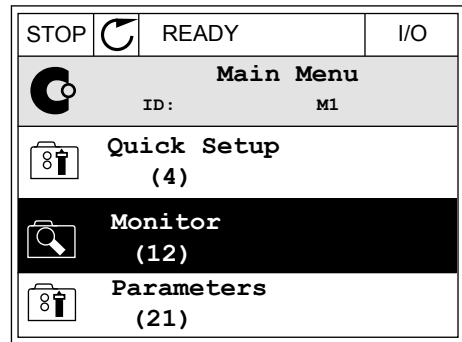

2 Go into Multimonitor.

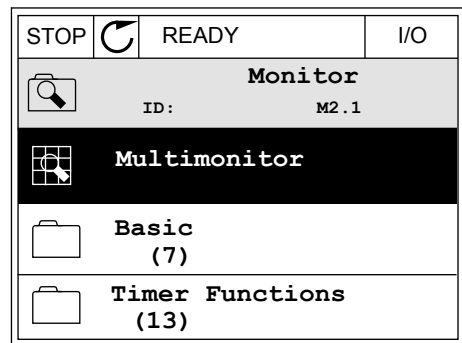

3 To replace an old item, activate it. Use the arrow buttons.

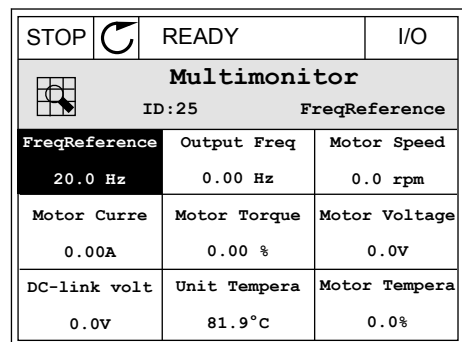

- 4 To make a selection of a new item in the list, push OK.

STOP		READY	I/O
FreqReference			
ID:1		M2.1.1.1	
<input checked="" type="checkbox"/>	Output frequency	0.00 Hz	
<input checked="" type="checkbox"/>	FreqReference	10.00 Hz	
<input checked="" type="checkbox"/>	Motor Speed	0.00 rpm	
<input checked="" type="checkbox"/>	Motor Current	0.00 A	
<input checked="" type="checkbox"/>	Motor Torque	0.00 %	
<input type="checkbox"/>	Motor Power	0.00 %	

4.1.2 BASIC

The basic monitoring values are the actual values of selected parameters, signals, statuses and measurements. The different applications may have different number of monitoring values.

You can see the basic monitoring values and their related data in the next table.



NOTE!

Only the standard I/O board statuses are available in the Monitor menu. You can find the statuses of all the I/O board signals as raw data in the I/O and Hardware system menu.

Do a check of the statuses of the expander I/O board in the I/O and Hardware system menu when the system asks you to do it.

Table 3: Items in the monitoring menu

Index	Monitoring value	Unit	ID	Description
V2.2.1	Output frequency	Hz	1	The output frequency to motor
V2.2.2	Frequency reference	Hz	25	The frequency reference to motor control
V2.2.3	Motor speed	rpm	2	The actual speed of the motor in rpm
V2.2.4	Motor current	A	3	Motor current
V2.2.5	Motor torque	%	4	The calculated shaft torque
V2.2.7	Motor shaft power	%	5	The calculated motor shaft power in percentage
V2.2.8	Motor shaft power	kW/hp	73	The calculated motor shaft power in kW or hp. The unit is set in the unit selection parameter.
V2.2.9	Motor voltage	V	6	The output voltage to motor
V2.2.10	DC link voltage	V	7	The measured voltage in the DC-link of the drive
V2.2.11	Unit temperature	°C	8	The heatsink temperature in Celsius or Fahrenheit
V2.2.12	Motor temperature	%	9	The calculated motor temperature in percentage of the nominal working temperature
V2.2.13	Analogue input 1	%	59	The signal in percentage of the used range.
V2.2.14	Analogue input 2	%	60	The signal in percentage of the used range.
V2.2.15	Analogue output 1	%	81	The signal in percentage of the used range.
V2.2.16	Motor Preheat		1228	The status of the Motor preheat function 0 = OFF 1 = Heating (feeding DC-current)
V2.2.17	Drive Status Word		43	The bit coded status of the AC drive. B1 = Ready B2 = Run B3 = Fault B6 = RunEnable B7 = AlarmActive B10 = DC Current in stop B11 = DC Brake Active B12 = RunRequest B13 = MotorRegulatorActive
V2.2.19	Fire mode status		1597	0 = Disabled 1 = Enabled 2 = Activated 3 = Test mode

Table 3: Items in the monitoring menu

Index	Monitoring value	Unit	ID	Description
V2.2.20	DIN Status Word 1		56	The 16-bit word where each bit tells the status of 1 digital input. 6 digital inputs at every slot are read. Word 1 starts from input 1 in slot A (bit0) and goes to input 4 in slot C (bit15).
V2.2.21	DIN Status Word 2		57	The 16-bit word where each bit tells the status of 1 digital input. 6 digital inputs at every slot are read. Word 2 starts from input 5 in slot C (bit0) and goes to input 6 in slot E (bit13).
V2.2.22	Motor current with 1 decimal		45	The monitor value for the motor current with a fixed number of decimals and less filtering. With this parameter you can, for example, use the fieldbus to always read the correct value regardless of the frame size. You can also use this to monitor when less filtering time is needed for the motor current.
V2.2.23	Appl.StatusWord 1		89	The bit coded Application Status Word 1. B0 = Interlock1 B1 = Interlock2, B5 = I/O A Control Act. B6 = I/O B Control Act. B7 = Fieldbus Control Act. B8 = Local Control Act. B9 = PC Control Act. B10 = Preset Frequencies Act. B12 = FireMode Act. B13 = PreHeat Act.
V2.2.24	Appl.StatusWord 2		90	The bit coded Application Status Word 2. B0 = Acc/Dec Prohibited B1 = MotorSwitch Act.
V2.2.25	kWhTripCounter Low		1054	The energy counter with a kWh output. (Low Word)
V2.2.26	kWhTripCounter High		1067	Determines how many times the energy counter has spinned around. (High Word)
V2.2.27	LastActiveFaultCode		37	The fault code of the latest active fault that is not reset.
V2.2.28	LastActiveFault ID		95	The fault ID of the latest active fault that is not reset.
V2.2.29	LastActiveAlarm-Code		74	The alarm code of the latest active alarm that is not reset.
V2.2.30	LastActiveAlarm ID		94	The alarm ID of the latest active alarm that is not reset.

Table 3: Items in the monitoring menu

Index	Monitoring value	Unit	ID	Description
V2.2.31	U Phase Current	A	39	The measured value of the motor phase current (with 1 s filtering).
V2.2.32	V Phase Current	A	40	The measured value of the motor phase current (with 1 s filtering).
V2.2.33	W Phase Current	A	41	The measured value of the motor phase current (with 1 s filtering).
V2.2.34	MotorRegulat.Status		77	B0: Current limit (Motor) B1: Current limit (Generator) B2: Torque limit (Motor) B3: Torque limit (Generator) B4: Overvoltage control B5: Undervoltage control B6: Power limit (Motor) B7: Power limit (Generator)

4.1.3 TIMER FUNCTIONS MONITORING

Monitor the values of Timer functions and the Real Time Clock.

Table 4: Monitoring of the timer functions

Index	Monitoring value	Unit	ID	Description
V2.3.1	TC 1, TC 2, TC 3		1441	You can monitor the statuses of the 3 time channels (TC)
V2.3.2	Interval 1		1442	The status of the timer interval
V2.3.3	Interval 2		1443	The status of the timer interval
V2.3.4	Interval 3		1444	The status of the timer interval
V2.3.5	Interval 4		1445	The status of the timer interval
V2.3.6	Interval 5		1446	The status of the timer interval
V2.3.7	Timer 1	s	1447	The remaining time on the timer if the timer is active
V2.3.8	Timer 2	s	1448	The remaining time on the timer if the timer is active
V2.3.9	Timer 3	s	1449	The remaining time on the timer if the timer is active
V2.3.10	Real time clock		1450	hh:mm:ss

4.1.4 PID1 CONTROLLER MONITORING

Table 5: Monitoring of the values of the PID1 controller

Index	Monitoring value	Unit	ID	Description
V2.4.1	PID1 setpoint	Varies	20	The setpoint value of the PID1 controller in process units. You can use a parameter to make the selection of the process unit.
V2.4.2	PID1 feedback	Varies	21	The feedback value of the PID1 controller in process units. You can use a parameter to make the selection of the process unit.
V2.4.3	PID1 error value	Varies	22	The error value of the PID1 controller. It is the deviation of feedback from the setpoint in process units. You can use a parameter to make the selection of the process unit.
V2.4.4	PID1 output	%	23	The PID output as a percentage (0-100%). It is possible to give this value to the motor control (frequency reference) or to an analogue output.
V2.4.5	PID1 status		24	0 = Stopped 1 = Running 3 = Sleep mode 4 = In dead band (see Chapter 5.12 Group 3.12: PID-controller 1)

4.1.5 PID2 CONTROLLER MONITORING

Table 6: Monitoring of the values of the PID2 controller

Index	Monitoring value	Unit	ID	Description
V2.5.1	PID2 setpoint	Varies	83	The setpoint value of the PID2 controller in process units. You can use a parameter to make the selection of the process unit.
V2.5.2	PID2 feedback	Varies	84	The feedback value of the PID2 controller in process units. You can use a parameter to make the selection of the process unit.
V2.5.3	PID2 error value	Varies	85	The error value of the PID2 controller. It is the deviation of feedback from the setpoint in process units. You can use a parameter to make the selection of the process unit.
V2.5.4	PID2 output	%	86	The PID2 controller output as a percentage (0-100%). It is possible to give this value to, for example, the analogue output.
V2.5.5	PID2 status		87	0=Stopped 1=Running 2=In dead band (see Chapter 5.13 Group 3.13: PID-controller 2)

4.1.6 MULTI-PUMP MONITORING

Table 7: Multipump monitoring

Index	Monitoring value	Unit	ID	Description
V2.6.1	Motors running		30	The number of motors that operate when the Multi-pump function is used.
V2.6.2	Autochange		1114	The system tells you if an autochange is necessary.

4.1.7 FIELDBUS PROCESS DATA MONITORING

Table 8: Fieldbus data monitoring

Index	Monitoring value	Unit	ID	Description
V2.8.1	FB Control Word		874	The fieldbus control word that the application uses in bypass mode/format. Depending on the fieldbus type or profile, the data can be modified before it is sent to the application.
V2.8.2	FB Speed Reference		875	The speed reference scaled between the minimum and the maximum frequency at the moment when the application received it. You can change the minimum and the maximum frequencies after the application received the reference without an effect on the reference.
V2.8.3	FB data in 1		876	The raw value of process data in a 32-bit signed format
V2.8.4	FB data in 2		877	The raw value of process data in a 32-bit signed format
V2.8.5	FB data in 3		878	The raw value of process data in a 32-bit signed format
V2.8.6	FB data in 4		879	The raw value of process data in a 32-bit signed format
V2.8.7	FB data in 5		880	The raw value of process data in a 32-bit signed format
V2.8.8	FB data in 6		881	The raw value of process data in a 32-bit signed format
V2.8.9	FB data in 7		882	The raw value of process data in a 32-bit signed format
V2.8.10	FB data in 8		883	The raw value of process data in a 32-bit signed format
V2.8.11	FB Status Word		864	The fieldbus status word that the application sends in bypass mode/format. Depending on the fieldbus type or profile, the data can be modified before it is sent to the fieldbus.
V2.8.12	FB Speed Actual		865	The actual speed as a percentage. The value 0% agrees with the minimum frequency and the value 100% agrees with the maximum frequency. This is continuously updated depending on the momentary min and max frequencies and the output frequency.
V2.8.13	FB data out 1		866	The raw value of process data in a 32-bit signed format
V2.8.14	FB data out 2		867	The raw value of process data in a 32-bit signed format

Table 8: Fieldbus data monitoring

Index	Monitoring value	Unit	ID	Description
V2.8.15	FB data out 3		868	The raw value of process data in a 32-bit signed format
V2.8.16	FB data out 4		869	The raw value of process data in a 32-bit signed format
V2.8.17	FB data out 5		870	The raw value of process data in a 32-bit signed format
V2.8.18	FB data out 6		871	The raw value of process data in a 32-bit signed format
V2.8.19	FB data out 7		872	The raw value of process data in a 32-bit signed format
V2.8.20	FB data out 8		873	The raw value of process data in a 32-bit signed format

5 PARAMETERS MENU

The HVAC Application has the following parameter groups:

Menu and Parameter group	Description
Group 3.1: Motor settings	Basic and advanced motor settings.
Group 3.2: Start/Stop setup	Start and stop functions.
Group 3.3: Control reference settings	Frequency reference setup.
Group 3.4: Ramp & Brakes Setup	Acceleration/Deceleration setup.
Group 3.5: I/O Configuration	I/O programming.
Group 3.6: Fieldbus Data Mapping	Fieldbus data out parameters.
Group 3.7: Prohibit Frequencies	Prohibit frequencies programming.
Group 3.8: Limit supervisions	Programmable limit controllers.
Group 3.9: Protections	Protections configuration.
Group 3.10: Automatic reset	Auto reset after fault configuration.
Group 3.11: Timer functions	Configuration of 3 timers based on Real Time Clock.
Group 3.12: PID-controller 1	Parameters for PID Controller 1. Motor control or external usage.
Group 3.13: PID-controller 2	Parameters for PID Controller 2. External usage.
Group 3.14: Multi-pump	Parameters for multi-pump system.
Group 3.16: Fire mode	Parameters for Fire Mode.
Group 3.17 Application Settings	
Group 3.18 kWh Pulse Output	Parameters to configure a digital output that gives pulses that agree to the kWh counter.

5.1 GROUP 3.1: MOTOR SETTINGS



NOTE!

These parameters are locked if drive is in the run state.

Table 9: Motor nameplate parameters

Index	Parameter	Min	Max	Unit	Default	ID	Description
P3.1.1.1	Motor Nominal Voltage	Varies	Varies	V	Varies	110	Find the value U_n on the nameplate of the motor. Find out if the motor connection is Delta or Star.
P3.1.1.2	Motor Nominal Frequency	8.00	320.00	Hz	50 / 60	111	Find the value f_n on the nameplate of the motor.
P3.1.1.3	Motor Nominal Speed	24	19200	rpm	Varies	112	Find the value n_n on the rating plate of the motor.
P3.1.1.4	Motor Nominal Current	Varies	Varies	A	Varies	113	Find the value I_n on the nameplate of the motor.
P3.1.1.5	Motor Cos Phi	0.30	1.00		Varies	120	Find the value on the nameplate of the motor.
P3.1.1.6	Motor Nominal Power	Varies	Varies	kW	Varies	116	Find the value P_n on the nameplate of the motor.
P3.1.1.7 	Motor current limit	Varies	Varies	A	Varies	107	Maximum motor current of the AC drive
P3.1.1.8	Motor type	0	1		0	650	Make a selection of what motor type is used. 0 = asynchronous induction motor 1 = PM synchronous motor

Table 10: Motor control settings

Index	Parameter	Min	Max	Unit	Default	ID	Description
P3.1.2.1	Switching Frequency	1.5	Varies	kHz	Varies	601	If you increase the switching frequency, the capacity of the AC drive reduces. To reduce capacitive currents in the motor cable, when the cable is long, we recommend that you use a low switching frequency. To reduce the motor noise, use a high switching frequency.
P3.1.2.2	Motor Switch	0	1		0	653	When you enable this function, the drive does not trip when the motor switch is closed and opened, for example in a flying start. 0 = Disabled 1 = Enabled
P3.1.2.4	Zero Frequency Voltage	0.00	40.00	%	Varies	606	This parameter gives the zero frequency voltage of the U/f curve. The default value is different for different unit sizes.
P3.1.2.5	Motor preheat function	0	3		0	1225	0 = Not used 1 = Always in stop state 2 = Controlled by DI 3 = Temp limit (heat-sink) You can activate the virtual digital input with Real Time Clock

Table 10: Motor control settings





Index	Parameter	Min	Max	Unit	Default	ID	Description
P3.1.2.6	Motor preheat temperature limit	-20	80	°C	0	1226	The motor preheat becomes active when the heatsink temperature or the measured motor temperature goes below this level, and when the parameter P3.1.2.5 is set to Temperature limit. For example, if the temperature limit is 10 °C, the feeding current starts at 10 °C and stops at 11 °C (1-degree hysteresis).
P3.1.2.7	Motor preheat current	0	0.5*IL	A	Varies	1227	The DC current for the pre-heating of the motor and the drive in stop state. You can activate this parameter by digital input or by temperature limit.
P3.1.2.8 	U/f Ratio selection	0	1		Varies	108	The type of the U/f curve between zero frequency and the field weakening point. 0=Linear 1=Squared
P3.1.2.15 	Overvoltage Control	0	1		1	607	0 = Disabled 1 = Enabled
P3.1.2.16 	Undervoltage Control	0	1		1	608	0 = Disabled 1 = Enabled
P3.1.2.17 	Stator Voltage Adjust	50.0	150.0	%	100.0	659	Use this to adjust the stator voltage in permanent magnet motors.

Table 10: Motor control settings

Index	Parameter	Min	Max	Unit	Default	ID	Description
P3.1.2.18	Energy Optimization	0	1		0	666	The drive finds the minimum motor current to save energy and to lower the motor noise. You can use this function for example in fan and pump applications. 0 = Disabled 1 = Enabled
P3.1.2.19	Flying Start Options	0	1			1590	0 = Search the shaft direction from both directions 1 = Search the shaft frequency only from the same direction as the frequency reference
P3.1.2.20	I/f Start	0	1		0	534	0 = Disabled 1 = Enabled
P3.1.2.21	I/f Start Frequency	5.0	25	Hz	0.2 * P3.1.1.2	535	The output frequency limit below which the set I/f start current is fed to motor.
P3.1.2.22	I/f Start Current	0	100	%	80	536	The current that is fed to the motor when the I/f Start function is activated.

5.2 GROUP 3.2: START/STOP SETUP

Table 11: Start/stop setup menu

Index	Parameter	Min	Max	Unit	Default	ID	Description
P3.2.1	Remote Control Place	0	1		0	172	The selection of the remote control place (start/stop). Use this to change back to remote control from Vacon Live, for example if the control panel is broken. 0 = I/O control 1 = Fieldbus control
P3.2.2	Local/Remote	0	1		0	211	Switch between the local and remote control places. 0 = Remote 1 = Local
P3.2.3	Keypad Stop Button	0	1		0	114	0 = The Stop button always enabled (Yes) 1 = Limited function of the Stop button (No)
P3.2.4	Start Function	0	1		Varies	505	0 = Ramping 1 = Flying start
P3.2.5 	Stop Function	0	1		0	506	0 = Coasting 1 = Ramping

Table 11: Start/stop setup menu

Index	Parameter	Min	Max	Unit	Default	ID	Description
P3.2.6 	I/O A Start/Stop Logic	0	4		0	300	<p>Logic = 0 Ctrl sgn 1 = Forward Ctrl sgn 2 = Backward</p> <p>Logic = 1 Ctrl sgn 1 = Forward (edge) Ctrl sgn 2 = Inverted Stop</p> <p>Logic = 2 Ctrl sgn 1 = Forward (edge) Ctrl sgn 2 = Bckwrđ (edge)</p> <p>Logic = 3 Ctrl sgn 1 = Start Ctrl sgn 2 = Reverse</p> <p>Logic = 4 Ctrl sgn 1 = Start (edge) Ctrl sgn 2 = Reverse</p>
P3.2.7	I/O B Start/Stop Logic	0	4		0	363	See above.
P3.2.8	Fieldbus Start Logic	0	1		0	889	0 = A rising edge is necessary 1 = State

5.3 GROUP 3.3: CONTROL REFERENCE SETTINGS

Table 12: Control reference settings

Index	Parameter	Min	Max	Unit	Default	ID	Description
P3.3.1	Minimum Frequency	0.00	P3.3.2	Hz	0.00	101	The minimum frequency reference
P3.3.2	Maximum Frequency	P3.3.1	320.00	Hz	50.00	102	The maximum frequency reference
P3.3.3	I/O Control Reference A Selection	1	11		6	117	Selection of the reference source when the control place is I/O A. 1 = Preset Frequency 0 2 = Keypad reference 3 = Fieldbus 4 = AI1 5 = AI2 6 = AI1+AI2 7 = PID 1 reference 8 = Motor potentiometer 9 = Average (AI1, AI2) 10 = Min (AI1, AI2) 12 = Max (AI1, AI2)
P3.3.4	I/O Control Reference B Selection	1	10		4	131	Selection of the reference source when the control place is I/O B. See above. You can force the I/O B control place to be active only with a digital input (P3.5.1.5).
P3.3.5	Keypad Ctrl Reference Selection	1	8		2	121	Selection of the reference source when the control place is keypad. 1 = Preset Frequency 0 2 = Keypad 3 = Fieldbus 4 = AI1 5 = AI2 6 = AI1+AI2 7 = PID 1 reference 8 = Motor potentiometer
P3.3.6	Keypad Reference	0.00	P3.3.2	Hz	0.00	184	You can adjust the frequency reference on the keypad with this parameter.

Table 12: Control reference settings



Index	Parameter	Min	Max	Unit	Default	ID	Description
P3.3.7	Keypad Direction	0	1		0	123	The rotation direction of the motor when the control place is keypad. 0 = Forward 1 = Reverse
P3.3.8	Keypad reference copy	0	2		1	181	When the control place is changed to keypad, selects if the Run state and Reference are copied. If the Reference is copied, it replaces the parameter 3.3.6 Keypad Reference. 0 = Copy reference 1 = Copy ref & Run state 2 = No copying
P3.3.9	Fieldbus Control Reference Selection	0	8		3	122	Selection of the reference source when the control place is Fieldbus. 1 = Preset frequency 0 2 = Keypad 3 = Fieldbus 4 = AI1 5 = AI2 6 = AI1+AI2 7 = PID 1 reference 8 = Motor potentiometer
P3.3.10 	Preset Frequency Mode	0	1		0	182	0 = Binary coded 1 = Number of inputs The number of preset speed digital inputs that are active define the preset frequency.
P3.3.11 	Preset Frequency 0	P3.3.1	P3.3.2	Hz	5.00	180	The basic preset frequency 0 when it is set with P3.3.3.

Table 12: Control reference settings







Index	Parameter	Min	Max	Unit	Default	ID	Description
P3.3.12 	Preset Frequency 1	P3.3.1	P3.3.1	Hz	10.00	105	Make the selection with digital input Pre-set frequency selection 0 (P3.5.1.15).
P3.3.13 	Preset Frequency 2	P3.3.1	P3.3.1	Hz	15.00	106	Make the selection with digital input Pre-set frequency selection 1 (P3.5.1.16).
P3.3.14 	Preset Frequency 3	P3.3.1	P3.3.1	Hz	20.00	126	Make the selection with digital inputs Pre-set frequency selection 0 & 1.
P3.3.15 	Preset Frequency 4	P3.3.1	P3.3.1	Hz	25.00	127	Make the selection with digital input Pre-set frequency selection 2 (P3.5.1.17).
P3.3.16 	Preset Frequency 5	P3.3.1	P3.3.1	Hz	30.00	128	Make the selection with digital inputs Pre-set frequency selection 0 & 2.
P3.3.17 	Preset Frequency 6	P3.3.1	P3.3.1	Hz	40.00	129	Make the selection with digital inputs Pre-set frequency selection 1 & 2.
P3.3.18 	Preset Frequency 7	P3.3.1	P3.3.1	Hz	50.00	130	Make the selection with digital inputs Pre-set frequency selection 0 & 1 & 2.
P3.3.19	Preset alarm frequency	P3.3.1	P3.3.2	Hz	25.00	183	This frequency is used when the fault response (in Group 3.9: Protections) is Alarm + preset frequency. Use this frequency only when the fault that triggered this alarm frequency is active.
P3.3.20	Motor Potentiometer Ramp Time	0.1	500.0	Hz/s	10.0	331	The rate of change in the motor potentiometer reference when it is increased or decreased.

Table 12: Control reference settings

Index	Parameter	Min	Max	Unit	Default	ID	Description
P3.3.21	Motor Potentiometer Reset	0	2		1	367	The reset logic for the motor potentiometer frequency reference. 0 = No reset 1 = Reset if stopped 2 = Reset if powered down
P3.3.22	Reverse direction	0	1		0	15530	This parameter controls the function to run the motor in reverse direction. If running the motor in reverse can cause a risk of damage to the process, set this parameter to 'Reverse prevented'. 0 = Reverse allowed 1 = Reverse prevented

5.4 GROUP 3.4: RAMP AND BRAKES SETUP

Table 13: Ramp and brakes setup



Index	Parameter	Min	Max	Unit	Default	ID	Description
P3.4.1 	Ramp 1 Shape	0.0	10.0	s	0.0	500	You can make smoother the start and the end of the acceleration and deceleration ramps.
P3.4.2	Acceleration Time 1	0.1	3000.0	s	20.0	103	Gives the time that is necessary for the output frequency to increase from zero frequency to maximum frequency.
P3.4.3	Deceleration Time 1	0.1	3000.0	s	20.0	104	Gives the time that is necessary for the output frequency to decrease from maximum frequency to zero frequency.
P3.4.4	Ramp 2 Shape	0.0	10.0	s	0.0	501	You can make smoother the start and the end of the acceleration and deceleration ramps.
P3.4.5	Acceleration Time 2	0.1	3000.0	s	20.0	502	Gives the time that is necessary for the output frequency to increase from zero frequency to maximum frequency.
P3.4.6	Deceleration Time 2	0.1	3000.0	s	20.0	503	Gives the time that is necessary for the output frequency to decrease from maximum frequency to zero frequency.
P3.4.7	Start Magnetising Time	0.00	600.00	s	0.00	516	Gives the time during which the DC current is fed to the motor before the acceleration starts.
P3.4.8	Start Magnetising Current	Varies	Varies	A	Varies	517	
P3.4.9	DC Braking Time at Stop	0.00	600.00	s	0.00	508	Tells if the braking is ON or OFF and gives the braking time when the motor stops.

Table 13: Ramp and brakes setup

Index	Parameter	Min	Max	Unit	Default	ID	Description
P3.4.10	DC Brake Current	Varies	Varies	A	Varies	507	Gives the current that is fed into the motor during DC braking. 0 = Disabled
P3.4.11	Frequency to Start DC Braking at Ramp Stop	0.10	10.00	Hz	1.50	515	The output frequency at which the DC braking starts.
P3.4.12 	Flux Braking	0	1		0	520	0 = Disabled 1 = Enabled
P3.4.13	Flux Braking Current	0	Varies	A	Varies	519	Gives the current level for the flux braking.

5.5 GROUP 3.5: I/O CONFIGURATION

Table 14: Digital input settings



Index	Parameter	Default	ID	Description
P3.5.1.1	Control Signal 1 A	DigIN SlotA.1	403	Start signal 1 when the control place is I/O A (FWD).
P3.5.1.2	Control Signal 2 A	DigIN SlotA.2	404	Start signal 2 when the control place is I/O A (REV).
P3.5.1.3	Control Signal 1 B	DigIN Slot0.1	423	Start signal 1 when the control place is I/O B.
P3.5.1.4	Control Signal 2 B	DigIN Slot0.1	424	Start signal 2 when the control place is I/O B.
P3.5.1.5	I/O B Control Force	DigIN Slot0.1	425	CLOSED = Force the control place to I/O B.
P3.5.1.6	I/O B Reference Force	DigIN Slot0.1	343	CLOSED = I/O reference B (P3.3.4) gives the frequency reference.
P3.5.1.7	External Fault Close	DigIN SlotA.3	405	OPEN = OK CLOSED = External fault
P3.5.1.8	External Fault Open	DigIN Slot0.2	406	OPEN = External fault CLOSED = OK
P3.5.1.9	Fault Reset Close	DigIN SlotA.6	414	Resets all active faults when the state of the digital input is changed from 0 to 1 (rising edge).
P3.5.1.10	Fault Reset Open	DigIN Slot0.1	213	Resets all active faults when the state of the digital input is changed from 1 to 0 (falling edge).
P3.5.1.11	 Run Enable	DigIN Slot0.2	407	You can set the drive in Ready state, when this is ON.
P3.5.1.12	 Run Interlock 1	DigIN Slot0.2	1041	The drive can be ready, but the start is not possible when the interlock is on (Damper interlock).
P3.5.1.13	 Run Interlock 2	DigIN Slot0.2	1042	As above.

Table 14: Digital input settings



Index	Parameter	Default	ID	Description
P3.5.1.14	Motor Preheat ON	DigIN Slot0.1	1044	OPEN = No action. CLOSED = Uses the DC current of the motor preheat in Stop state. Used when the value of P3.1.2.5 is 2.
P3.5.1.15 	Preset Frequency Selection 0	DigIN SlotA.4	419	A binary selector for preset speeds (0-7). See <i>Table 12 Control reference settings</i> .
P3.5.1.16 	Preset Frequency Selection 1	DigIN SlotA.5	420	A binary selector for preset speeds (0-7). See <i>5.3 Group 3.3: Control reference settings</i> .
P3.5.1.17 	Preset Frequency Selection 2	DigIN Slot0.1	421	A binary selector for preset speeds (0-7). See <i>Table 12 Control reference settings</i> .
P3.5.1.18	Timer 1	DigIN Slot0.1	447	The rising edge starts Timer 1 that was programmed in Group 3.11: Timer functions.
P3.5.1.19	Timer 2	DigIN Slot0.1	448	See above.
P3.5.1.20	Timer 3	DigIN Slot0.1	449	See above.
P3.5.1.21	Disable Timer Function	DigIN Slot0.1	1499	This digital input signal controls all timer functions (for example, Intervals 1-5 and Timers 1-3). CLOSED = Disables the Timer functions and resets timers. OPEN = Enables the Timer functions.
P3.5.1.22	PID1 Setpoint Boost	DigIN Slot0.1	1047	OPEN = No boost CLOSED = Boost
P3.5.1.23	PID1 Select Setpoint	DigIN Slot0.1	1046	OPEN = Setpoint 1 CLOSED = Setpoint 2
P3.5.1.24	PID2 Start Signal	DigIN Slot0.2	1049	OPEN = PID2 in stop mode CLOSED = PID2 regulating This parameter has no effect if the PID2 controller is not enabled in the Basic menu for PID2

Table 14: Digital input settings

Index	Parameter	Default	ID	Description
P3.5.1.25	PID2 Select Setpoint	DigIN Slot0.1	1048	OPEN = Setpoint 1 CLOSED = Setpoint 2
P3.5.1.26	Motor 1 Interlock	DigIN Slot0.2	426	OPEN = Not active CLOSED = Active
P3.5.1.27	Motor 2 Interlock	DigIN Slot0.1	427	OPEN = Not active CLOSED = Active
P3.5.1.28	Motor 3 Interlock	DigIN Slot0.1	428	OPEN = Not active CLOSED = Active
P3.5.1.29	Motor 4 Interlock	DigIN Slot0.1	429	OPEN = Not active CLOSED = Active
P3.5.1.30	Motor 5 Interlock	DigIN Slot0.1	430	OPEN = Not active CLOSED = Active
P3.5.1.31	Motor Potentiometer UP	DigIN Slot0.1	418	OPEN = Not active CLOSED = Active. The motor potentiometer reference INCREASES until the contact is open.
P3.5.1.32	Motor Potentiometer DOWN	DigIN Slot0.1	417	OPEN = Not active CLOSED = Active. The motor potentiometer reference DECREASES until the contact is open.
P3.5.1.33	Acc/Dec Time Sel	DigIN Slot0.1	408	Switch between ramps 1 and 2. OPEN = Ramp 1 Shape, Acceleration Time 1 and Deceleration Time 1. CLOSED = Ramp 2 Shape, Acceleration Time 2 and Deceleration Time 2.
P3.5.1.34	Fieldbus control	DigIN Slot0.1	441	CLOSED = Forces control place to fieldbus

Table 14: Digital input settings

Index	Parameter	Default	ID	Description
P3.5.1.39	Fire Mode Activation OPEN	DigIN Slot0.2	1596	Activates the Fire mode if it is enabled with a correct password. OPEN = Active CLOSED = Inactive
P3.5.1.40	Fire Mode Activation CLOSE	DigIN Slot0.1	1619	Activates the Fire mode if it is enabled with a correct password. OPEN = Inactive CLOSED = Active
P3.5.1.41	Fire Mode Reverse	DigIN Slot0.1	1618	Gives a command of reverse rotation direction during Fire mode. This function has no effect in normal operation.
P3.5.1.42	Keypad CTRL	DigIn Slot0.1	410	Forces control place to keypad.
P3.5.1.43	Reset kWh Trip Counter	DigIn Slot0.1	1053	Resets the kWh Trip Counter
P3.5.1.44	Fire mode preset frequency selection 0	DigIn Slot0.1	15531	Before you can activate the selection, set the Fire Mode frequency source to Fire Mode frequency.
P3.5.1.45	Fire mode preset frequency selection 1	DigIn Slot0.1	15532	Before you can activate the selection, set the Fire Mode frequency source to Fire Mode frequency.
P3.5.1.46	Param. Set 1/2 Sel.	DigIN Slot0.1	496	Selection for the parameter set (1 or 2). OPEN = Parameter Set 1 CLOSED = Parameter Set 2

Table 15: Analogue input settings

Index	Parameter	Min	Max	Unit	Default	ID	Description
P3.5.2.1	AI1 Signal Selection				AnIN SlotA.1	377	Connect the AI1 signal to the analogue input of your choice with this parameter. Programmable.
P3.5.2.2	 AI1 Filter Time	0.0	300.0	s	1.0	378	The filter time for the analogue input. A value higher than 0 activates the low pass filtering function for this signal. The filtering time is the time it takes to reach 63 % of a step change in the signal.
P3.5.2.3	AI1 Signal Range	0	1		0	379	0 = 0–10V / 0–20mA 1 = 2–10V / 4–20mA
P3.5.2.4	AI1 Custom. Min	-160.00	160.00	%	0.00	380	The custom range minimum setting, 20% = 4–20 mA/2–10 V
P3.5.2.5	AI1 Custom. Max	-160.00	160.00	%	100.00	381	The custom range maximum setting.
P3.5.2.6	AI1 Signal Inversion	0	1		0	387	0 = Normal 1 = Signal inverted
P3.5.2.7	AI2 Signal Selection				AnIN SlotA.2	388	See P3.5.2.1
P3.5.2.8	AI2 Filter Time	0.0	300.0	s	1.0	389	See P3.5.2.2
P3.5.2.9	AI2 Signal Range	0	1		1	390	See P3.5.2.3
P3.5.2.10	AI2 Custom. Min	-160.00	160.00	%	0.00	391	See P3.5.2.4
P3.5.2.11	AI2 Custom. Max	-160.00	160.00	%	100.00	392	See P3.5.2.5
P3.5.2.12	AI2 Signal Inversion	0	1		0	398	See P3.5.2.6
P3.5.2.13	AI3 Signal Selection				AnIN Slot0.1	141	See P3.5.2.1
P3.5.2.14	AI3 Filter Time	0.0	300.0	s	1.0	142	See P3.5.2.2
P3.5.2.15	AI3 Signal Range	0	1		0	143	See P3.5.2.3
P3.5.2.16	AI3 Custom. Min	-160.00	160.00	%	0.00	144	See P3.5.2.4
P3.5.2.17	AI3 Custom. Max	-160.00	160.00	%	100.00	145	See P3.5.2.5

Table 15: Analogue input settings

Index	Parameter	Min	Max	Unit	Default	ID	Description
P3.5.2.18	AI3 Signal Inversion	0	1		0	151	See P3.5.2.6
P3.5.2.19	AI4 Signal Selection				AnIN Slot0.1	152	See P3.5.2.1
P3.5.2.20	AI4 Filter Time	0.0	300.0	s	1.0	153	See P3.5.2.2
P3.5.2.21	AI4 Signal Range	0	1		0	154	See P3.5.2.3
P3.5.2.22	AI4 Custom. Min	-160.00	160.00	%	0.00	155	See P3.5.2.4
P3.5.2.23	AI4 Custom. Max	-160.00	160.00	%	100.00	156	See P3.5.2.5
P3.5.2.24	AI4 Signal Inversion	0	1		0	162	See P3.5.2.6
P3.5.2.25	AI5 Signal Selection				AnIN Slot0.1	188	See P3.5.2.1
P3.5.2.26	AI5 Filter Time	0.0	300.0	s	1.0	189	See P3.5.2.2
P3.5.2.27	AI5 Signal Range	0	1		0	190	See P3.5.2.3
P3.5.2.28	AI5 Custom. Min	-160.00	160.00	%	0.00	191	See P3.5.2.4
P3.5.2.29	AI5 Custom. Max	-160.00	160.00	%	100.00	192	See P3.5.2.5
P3.5.2.30	AI5 Signal Inversion	0	1		0	198	See P3.5.2.6
P3.5.2.31	AI6 Signal Selection				AnIN Slot0.1	199	See P3.5.2.1
P3.5.2.32	AI6 Filter Time	0.0	300.0	s	1.0	200	See P3.5.2.2
P3.5.2.33	AI6 Signal Range	0	1		0	201	See P3.5.2.3
P3.5.2.34	AI6 Custom. Min	-160.00	160.00	%	0.00	202	See P3.5.2.4
P3.5.2.35	AI6 Custom. Max	-160.00	160.00	%	100.00	203	See P3.5.2.5
P3.5.2.36	AI6 Signal Inversion	0	1		0	209	See P3.5.2.6

Table 16: Digital output settings on standard I/O board



Index	Parameter	Min	Max	Unit	Default	ID	Description
P3.5.3.2.1 	Basic R01 Function	0	41		0	11001	<p>The function selection for Basic R01</p> <p>0 = None 1 = Ready 2 = Run 3 = Fault 4 = FaultInvert 5 = Alarm 6 = Reverse 7 = At speed 8 = Motor regulator active 9 = Preset speed 10 = Keypad control 11 = I/O B control 12 = Limit supervision 1 13 = Limit supervision 2 14 = Start signal 15 = Reserved 16 = Fire mode activation 17 = RTC time channel 1 control 18 = RTC time channel 2 control 19 = RTC time channel 3 control 20 = FB ControlWord B13 21 = FB ControlWord B14 22 = FB ControlWord B15 23 = PID 1 in Sleep mode 24 = Reserved 25 = PID1 supervision limits 26 = PID2 supervision limits 27 = Motor 1 control 28 = Motor 2 control</p>

Table 16: Digital output settings on standard I/O board

Index	Parameter	Min	Max	Unit	Default	ID	Description
P3.5.3.2.1 	Basic R01 Function	0	41		0	11001	29 = Motor 3 control 30 = Motor 4 control 31 = Motor 5 control 32 = Reserved 33 = Reserved 34 = Maintenance alarm 35 = Maintenance fault 36 = Thermistor fault 37 = Motor switch 38 = PreHeat 39 = kWh pulse output 40 = Run Indication 41 = Selected Param. Set
P3.5.3.2.2	Basic R01 ON Delay	0.00	320.00	s	0.00	11002	The ON delay for the relay.
P3.5.3.2.3	Basic R01 OFF Delay	0.00	320.00	s	0.00	11003	The OFF delay for the relay.
P3.5.3.2.4	Basic R02 Function	0	39		3	11004	See P3.5.3.2.1.
P3.5.3.2.5	Basic R02 ON Delay	0.00	320.00	s	0.00	11005	See P3.5.3.2.2.
P3.5.3.2.6	Basic R02 OFF Delay	0.00	320.00	s	0.00	11006	See P3.5.3.2.3.
P3.5.3.2.7	Basic R03 Function	0	39		1	11007	See P3.5.3.2.1. Not visible if only 2 output relays are installed.

THE DIGITAL OUTPUTS OF THE EXPANDER SLOTS C, D AND E

Shows only the parameters for the outputs on option boards in slots C, D and E. Make the selections as in Basic R01 Function (P3.5.3.2.1).

This group or these parameters are not visible if there are no digital outputs in slots C, D or E.

Table 17: Standard I/O board analogue output settings

Index	Parameter	Min	Max	Unit	Default	ID	Description
P3.5.4.1.1	A01 function	0	PID feed- back		2	10050	<p>0 = TEST 0% (Not used) 1 = TEST 100% 2 = Output freq (0 - fmax) 3 = Freq reference (0 - fmax) 4 = Motor speed (0 - Motor nominal speed) 5 = Output current (0 - I_nMotor) 6 = Motor torque (0 - T_nMotor) 7 = Motor power (0 - P_nMotor) 8 = Motor voltage (0 - U_nMotor) 9 = DC link voltage (0 - 1000V) 10 = PID1 output (0-100%) 11 = PID2 output (0-100%) 12 = ProcessDataIn1 (0-100%) 13 = ProcessDataIn2 (0-100%) 14 = ProcessDataIn3 (0-100%) 15 = ProcessDataIn4 (0-100%) 16 = ProcessDataIn5 (0-100%) 17 = ProcessDataIn6 (0-100%) 18 = ProcessDataIn7 (0-100%) 19 = ProcessDataIn8 (0-100%)</p> <p>For ProcessDataIn, use value without a decimal separator, for example, 5000 =50.00%.</p>
P3.5.4.1.2	A01 filter time	0.0	300.0	s	1.0	10051	<p>The filter time of the analogue output signal. See P3.5.2.2.</p> <p>0 = No filtering</p>

Table 17: Standard I/O board analogue output settings

Index	Parameter	Min	Max	Unit	Default	ID	Description
P3.5.4.1.3	A01 minimum	0	1		0	10052	0 = 0 mA / 0V 1 = 4 mA / 2V Make the selection of the signal type (current/voltage) with the dip switches. The analogue output scaling is different in P3.5.4.1.4.
P3.5.4.1.4	A01 minimum scale	Varies	Varies	Varies	0.0	10053	The minimum scale in process unit. Depends on the selection of the A01 function.
P3.5.4.1.5	A01 maximum scale	Varies	Varies	Varies	0.0	10054	The maximum scale in process unit. Depends on the selection of the A01 function.

SLOT C, D AND E ANALOGUE OUTPUTS

Shows only parameters for existing outputs in slot C/D/E. The selections are the same as in Basic A01. This group or these parameters are not visible if there are no digital outputs in slots C, D or E.

5.6 GROUP 3.6: FIELDBUS DATA MAPPING

Table 18: Fieldbus data mapping

Index	Parameter	Min	Max	Unit	Default	ID	Description
P3.6.1	Fieldbus Data Out 1 Selection	0	35000		1	852	Make the selection of the data that is sent to fieldbus with the ID of the parameter or monitor. The data is scaled to an unsigned 16-bit format according to the format on the control panel. For example, 25.5 on the display agrees with 255.
P3.6.2	Fieldbus Data Out 2 Selection	0	35000		2	853	Make the selection of the Process Data Out with the parameter ID.
P3.6.3	Fieldbus Data Out 3 Selection	0	35000		45	854	Make the selection of the Process Data Out with the parameter ID.
P3.6.4	Fieldbus Data Out 4 Selection	0	35000		4	855	Make the selection of the Process Data Out with the parameter ID.
P3.6.5	Fieldbus Data Out 5 Selection	0	35000		5	856	Make the selection of the Process Data Out with the parameter ID.
P3.6.6	Fieldbus Data Out 6 Selection	0	35000		6	857	Make the selection of the Process Data Out with the parameter ID.
P3.6.7	Fieldbus Data Out 7 Selection	0	35000		7	858	Make the selection of the Process Data Out with the parameter ID.
P3.6.8	Fieldbus Data Out 8 Selection	0	35000		37	859	Make the selection of the Process Data Out with the parameter ID.

Table 19: The default values for Process Data Out in fieldbus

Data	Default value	Scale
Process Data Out 1	Output frequency	0.01 Hz
Process Data Out 2	Motor speed	1 rpm
Process Data Out 3	Motor current	0.1 A
Process Data Out 4	Motor torque	0.1%
Process Data Out 5	Motor power	0.1%
Process Data Out 6	Motor voltage	0.1 V
Process Data Out 7	DC link voltage	1 V
Process Data Out 8	Last active fault code	1

For example, the value *2500* for Output frequency agrees with 25.00 Hz, because the scale is 0.01. All the monitoring values that you can find in Chapter 4.1 *Monitor group* are given the scale value.

5.7 GROUP 3.7: PROHIBIT FREQUENCIES

Table 20: Prohibit frequencies

Index	Parameter	Min	Max	Unit	Default	ID	Description
P3.7.1	Prohibit Frequency Range 1 Low Limit	-1.00	320.00	Hz	0.00	509	0 = Not used
P3.7.2	Prohibit Frequency Range 1 High Limit	0.00	320.00	Hz	0.00	510	0 = Not used
P3.7.3	Prohibit Frequency Range 2 Low Limit	0.00	320.00	Hz	0.00	511	0 = Not used
P3.7.4	Prohibit Frequency Range 2 High Limit	0.00	320.00	Hz	0.00	512	0 = Not used
P3.7.5	Prohibit Frequency Range 3 Low Limit	0.00	320.00	Hz	0.00	513	0 = Not used
P3.7.6	Prohibit Frequency Range 3 High Limit	0.00	320.00	Hz	0.00	514	0 = Not used
P3.7.7	Ramp Time Factor	0.1	10.0	Times	1.0	518	A multiplier of the set ramp time between prohibit frequency limits.

5.8 GROUP 3.8: LIMIT SUPERVISIONS

Table 21: Limits supervision settings

Index	Parameter	Min	Max	Unit	Default	ID	Description
P3.8.1	Supervision #1 Item Selection	0	7		0	1431	0 = Output frequency 1 = Frequency reference 2 = Motor current 3 = Motor torque 4 = Motor power 5 = DC-link voltage 6 = Analogue input 1 7 = Analogue input 2
P3.8.2	Supervision #1 Mode	0	2		0	1432	0 = Not used 1 = Low limit supervision (output active over limit) 2 = High limit supervision (output active under limit)
P3.8.3	Supervision #1 Limit	-200.00	200.00	Varies	25.00	1433	The supervision limit for the set item. The unit shows automatically.
P3.8.4	Supervision #1 Limit Hysteresis	-200.00	200.00	Varies	5.00	1434	The supervision limit hysteresis for the set item. The unit is set automatically.
P3.8.5	Supervision #2 Item Selection	0	7		1	1435	See P3.8.1
P3.8.6	Supervision #2 Mode	0	2		0	1436	See P3.8.2
P3.8.7	Supervision #2 Limit	-200.00	200.00	Varies	40.00	1437	See P3.8.3
P3.8.8	Supervision #2 Limit Hysteresis	-200.00	200.00	Varies	5.00	1438	See P3.8.4

5.9 GROUP 3.9: PROTECTIONS

Table 22: Protections settings

Index	Parameter	Min	Max	Unit	Default	ID	Description
P3.9.1	Response to Analogue input low fault	0	4		0	700	0 = No action 1 = Alarm 2 = Alarm, set the pre-set fault frequency (P3.3.19) 3 = Fault (Stop according to stop mode) 4 = Fault (Stop by coasting)
P3.9.2	 Response to external fault	0	3		2	701	0 = No action 1 = Alarm 2 = Fault (Stop according to stop mode) 3 = Fault (Stop by coasting)
P3.9.3	Response to Input phase fault	0	1		0	730	Select the supply phase configuration. The input phase supervision makes sure that the input phases of the frequency converter have an approximately equal current. 0 = 3 Phase Support 1 = 1 Phase Support
P3.9.4	Undervoltage Fault	0	1		0	727	0 = Fault stored in history 1 = Fault not stored in history
P3.9.5	Response to Output Phase Fault	0	3		2	702	See P3.9.2.
P3.9.6	Motor Thermal Protection	0	3		2	704	See P3.9.2.
P3.9.7	Motor ambient temperature factor	-20.0	100.0	°C	40.0	705	The ambient temperature in °C.

Table 22: Protections settings







Index	Parameter	Min	Max	Unit	Default	ID	Description
P3.9.8 	Motor thermal zero speed cooling	5.0	150.0	%	60.0	706	Gives the cooling factor at zero speed in relation to the point where the motor operates at nominal speed without an external cooling.
P3.9.9 	Motor Thermal Time Constant	1	200	min	Varies	707	The time constant is the time within which the calculated thermal stage has reached 63% of its final value.
P3.9.10 	Motor Thermal Loadability	0	150	%	100	708	
P3.9.11	Motor Stall Fault	0	3		0	709	See P3.9.2.
P3.9.12 	Stall Current	0.00	2*I _H	A	I _H	710	For a stall state to occur, the current must be above this limit.
P3.9.13 	Stall Time Limit	1.00	120.00	s	15.00	711	This is the maximum time for a stall state.
P3.9.14	Stall Frequency Limit	1.00	P3.3.2	Hz	25.00	712	For a stall state to occur, the output frequency must be below this limit for a time set in parameter P3.9.13 Stall Time Limit.
P3.9.15	Underload Fault (broken belt/dry pump)	0	3		0	713	See P3.9.2.
P3.9.16 	Underload Protection: Field Weakening Area Load	10.0	150.0	%	50.0	714	Gives the value for the minimum torque that is possible when the output frequency is bigger than the field weakening point.

Table 22: Protections settings

Index	Parameter	Min	Max	Unit	Default	ID	Description
P3.9.17	Underload Protection: Zero Frequency Load	5.0	150.0	%	10.0	715	Gives the value for the minimum torque that is possible with zero frequency. If you change the value of parameter P3.1.1.4, this parameter is automatically restored to the default value.
P3.9.18	Underload Protection: Time Limit	2.00	600.00	s	20.00	716	This is the maximum time for an underload state.
P3.9.19	Response to Fieldbus Communication Fault	0	4		3	733	See P3.9.1
P3.9.20	Slot Communication Fault	0	3		2	734	See P3.9.2.
P3.9.21	Thermistor Fault	0	3		0	732	See P3.9.2.
P3.9.22	Response to PID1 Supervision Fault	0	3		2	749	See P3.9.2.
P3.9.23	Response to PID2 Supervision Fault	0	3		2	757	See P3.9.2.
P3.9.25	TempFault Signal	0	3		Not used	739	Use this to select which signals show alarm and fault.
P3.9.26	TempAlarm Limit	-30.0	200		130.0	741	The temperature that shows an alarm.
P3.9.27	TempFault Limit	-30.0	200		155.0	742	The temperature that shows a fault.
P3.9.28	TempFault Response	0	3		Fault	740	A fault response to the Temperature Fault. 0 = No response 1 = Alarm 2 = Fault (Stop according to stop mode) 3 = Fault (Stop by coasting)
P3.9.29 * 	Response to Safe Torque Off (STO) Fault	0	2		2	775	0 = No action 1 = Alarm 2 = Fault (Stop by coasting)

*) This parameter is not visible if the drive does not have support for safety torque off functionality.

5.10 GROUP 3.10: AUTOMATIC RESET

Table 23: Autoreset settings





Index	Parameter	Min	Max	Unit	Default	ID	Description
P3.10.1 	Automatic Reset	0	1		1	731	0 = Disabled 1 = Enabled
P3.10.2	Restart Function	0	1		1	719	The selection of the start mode for Automatic reset. 0 = Flying start 1 = According to P3.2.4.
P3.10.3 	Wait Time	0.10	10000.00	s	0.50	717	The wait time before the first reset is done.
P3.10.4 	Trial Time	0.00	10000.00	s	60.00	718	When the trial time is over, and the fault is still active, the drive will trip.
P3.10.5 	Number of Trials	1	10		4	759	The total quantity of trials. The fault type does not have an effect on it. If the drive is not able to be reset with the quantity of trials and the set trial time, a fault shows.
P3.10.6	Autoreset: Under-voltage	0	1		1	720	Autoreset permitted? 0 = No 1 = Yes
P3.10.7	Autoreset: Over-voltage	0	1		1	721	Autoreset permitted? 0 = No 1 = Yes
P3.10.8	Autoreset: Over-current	0	1		1	722	Autoreset permitted? 0 = No 1 = Yes

Table 23: Autoreset settings

Index	Parameter	Min	Max	Unit	Default	ID	Description
P3.10.9	Autoreset: AI Low	0	1		1	723	Autoreset permitted? 0 = No 1 = Yes
P3.10.10	Autoreset: Unit Overtemperature	0	1		1	724	Autoreset permitted? 0 = No 1 = Yes
P3.10.11	Autoreset: Motor Overtemperature	0	1		1	725	Autoreset permitted? 0 = No 1 = Yes
P3.10.12	Autoreset: External Fault	0	1		0	726	Autoreset permitted? 0 = No 1 = Yes
P3.10.13	Autoreset: Underload Fault	0	1		0	738	Autoreset permitted? 0 = No 1 = Yes
P3.10.14	PID Supervision	No	Yes		No	15538	Autoreset permitted? 0 = No 1 = Yes

5.11 GROUP 3.11: TIMER FUNCTIONS

Table 24: 3.11.1 Interval 1

Index	Parameter	Min	Max	Unit	Default	ID	Description
P3.11.1.1	ON Time	00:00:00	23:59:59	hh:mm:ss	00:00:00	1464	The ON time
P3.11.1.2	OFF Time	00:00:00	23:59:59	hh:mm:ss	00:00:00	1465	The OFF time
P3.11.1.3	From day	0	6		0	1466	The day of the week when a function is activated. 0 = Sunday 1 = Monday 2 = Tuesday 3 = Wednesday 4 = Thursday 5 = Friday 6 = Saturday
P3.11.1.4	To day	0	6		0	1467	The day of the week when a function is deactivated. 0 = Sunday 1 = Monday 2 = Tuesday 3 = Wednesday 4 = Thursday 5 = Friday 6 = Saturday
P3.11.1.5	Assign to Channel				0	1468	The selection of the time channel. A checkbox selection 0 = Not used 1 = Time channel 1 2 = Time channel 2 3 = Time channel 3

Table 25: 3.11.2 Interval 2

Index	Parameter	Min	Max	Unit	Default	ID	Description
P3.11.2.1	ON Time	00:00:00	23:59:59	hh:mm:ss	00:00:00	1469	See Interval 1.
P3.11.2.2	OFF Time	00:00:00	23:59:59	hh:mm:ss	00:00:00	1470	See Interval 1.
P3.11.2.3	From day	0	6		0	1471	See Interval 1.
P3.11.2.4	To day	0	6		0	1472	See Interval 1.
P3.11.2.5	Assign to Channel	0	3		0	1473	See Interval 1.

Table 26: 3.11.3 Interval 3

Index	Parameter	Min	Max	Unit	Default	ID	Description
P3.11.3.1	ON Time	00:00:00	23:59:59	hh:mm:ss	00:00:00	1474	See Interval 1.
P3.11.3.2	OFF Time	00:00:00	23:59:59	hh:mm:ss	00:00:00	1475	See Interval 1.
P3.11.3.3	From day	0	6		0	1476	See Interval 1.
P3.11.3.4	To day	0	6		0	1477	See Interval 1.
P3.11.3.5	Assign to Channel	0	3		0	1478	See Interval 1.

Table 27: 3.11.4 Interval 4

Index	Parameter	Min	Max	Unit	Default	ID	Description
P3.11.4.1	ON Time	00:00:00	23:59:59	hh:mm:ss	00:00:00	1479	See Interval 1.
P3.11.4.2	OFF Time	00:00:00	23:59:59	hh:mm:ss	00:00:00	1480	See Interval 1.
P3.11.4.3	From day	0	6		0	1481	See Interval 1.
P3.11.4.4	To day	0	6		0	1482	See Interval 1.
P3.11.4.5	Assign to Channel	0	3		3	1483	See Interval 1.

Table 28: 3.11.5 Interval 5

Index	Parameter	Min	Max	Unit	Default	ID	Description
P3.11.5.1	ON Time	00:00:00	23:59:59	hh:mm:ss	00:00:00	1484	See Interval 1.
P3.11.5.2	OFF Time	00:00:00	23:59:59	hh:mm:ss	00:00:00	1485	See Interval 1.
P3.11.5.3	From day	0	6		0	1486	See Interval 1.
P3.11.5.4	To day	0	6		0	1487	See Interval 1.
P3.11.5.5	Assign to Channel	0	3		0	1488	See Interval 1.

Table 29: 3.11.6 Timer 1

Index	Parameter	Min	Max	Unit	Default	ID	Description
P3.11.6.1	Duration	0	72000	s	0	1489	The time that the timer runs when it is activated by DI.
P3.11.6.2	Assign to Channel	0	3		0	1490	The selection of the time channel. A checkbox selection 0 = Not used 1 = Time channel 1 2 = Time channel 2 3 = Time channel 3
P3.11.6.3	Mode	TOFF	TON		TOFF	15527	Select if the timer works with on delay or off delay.

Table 30: 3.11.7 Timer 2

Index	Parameter	Min	Max	Unit	Default	ID	Description
P3.11.7.1	Duration	0	72000	s	0	1491	See Timer 1.
P3.11.7.2	Assign to Channel	0	3		0	1492	See Timer 1.
P3.11.7.3	Mode	TOFF	TON		TOFF	15528	See Timer 1.

Table 31: 3.11.8 Timer 3

Index	Parameter	Min	Max	Unit	Default	ID	Description
P3.11.8.1	Duration	0	72000	s	0	1493	See Timer 1.
P3.11.8.2	Assign to Channel	0	3		0	1494	See Timer 1.
P3.11.8.3	Timer 3	TOFF	TON		TOFF	15523	See Timer 1.

5.12 GROUP 3.12: PID-CONTROLLER 1

Table 32: PID controller 1 basic settings

Index	Parameter	Min	Max	Unit	Default	ID	Description
P3.12.1.1	PID Gain	0.00	1000.00	%	100.00	118	If the value of the parameter is set to 100%, a change of 10% in the error value causes the controller output to change by 10%.
P3.12.1.2	PID Integration Time	0.00	600.00	s	1.00	119	If this parameter is set to 1.00 s, a change of 10% in the error value causes the controller output to change by 10.00%/s.
P3.12.1.3	PID Derivation Time	0.00	100.00	s	0.00	132	If this parameter is set to 1.00 s, a change of 10% in the error value during 1.00 s causes the controller output to change by 10.00%.
P3.12.1.4	Process Unit Selection	1	40		1	1036	Make a selection of the unit for the actual value.
P3.12.1.5	Process Unit Min	Varies	Varies	Varies	0	1033	
P3.12.1.6	Process Unit Max	Varies	Varies	Varies	100	1034	
P3.12.1.7	Process Unit Decimals	0	4		2	1035	The quantity of decimals of the process unit value.
P3.13.1.8	Error Inversion	0	1		0	340	0 = Normal (Feedback < Setpoint -> Increase PID output) 1 = Inverted (Feedback < Setpoint -> Decrease PID output)
P3.13.1.9 	Dead Band hysteresis	Varies	Varies	Varies	0	1056	The dead band area around the setpoint in process units. The PID output is locked if the feedback stays within the dead band area for the set time.

Table 32: PID controller 1 basic settings

Index	Parameter	Min	Max	Unit	Default	ID	Description
P3.12.1.10 	Dead Band Delay	0.00	320.00	s	0.00	1057	If the feedback stays in the dead band area for the set time, the output is locked.

Table 33: Setpoint settings

Index	Parameter	Min	Max	Unit	Default	ID	Description
P3.12.2.1	Keypad setpoint 1	Varies	Varies	Varies	0	167	
P3.12.2.2	Keypad setpoint 2	Varies	Varies	Varies	0	168	
P3.12.2.3	Setpoint ramp time	0.00	300.0	s	0.00	1068	Gives the rising and falling ramp times for the setpoint changes. That is, the time to change from the minimum to the maximum.
P3.12.2.4	Setpoint source 1 selection	0	16		1	332	<p>0 = Not used 1 = Keypad setpoint 1 2 = Keypad setpoint 2 3 = AI1 4 = AI2 5 = AI3 6 = AI4 7 = AI5 8 = AI6 9 = ProcessDataIn1 10 = ProcessDataIn2 11 = ProcessDataIn3 12 = ProcessDataIn4 13 = ProcessDataIn5 14 = ProcessDataIn6 15 = ProcessDataIn7 16 = ProcessDataIn8</p> <p>AI's and ProcessDataIn are handled as percentages (0.00- 100.00%) and scaled according to the setpoint minimum and maximum.</p> <p>ProcessDataIn signals use two decimals.</p>
P3.12.2.5	Setpoint 1 minimum	-200.00	200.00	%	0.00	1069	The minimum value at the analogue signal minimum.
P3.12.2.6	Setpoint 1 maximum	-200.00	200.00	%	100.00	1070	The maximum value at the analogue signal maximum.
P3.12.2.7 	Sleep Frequency limit 1	0.00	320.00	Hz	0.00	1016	The drive goes to sleep mode when the output frequency stays below this limit for a longer time than set by Sleep Delay.

Table 33: Setpoint settings



Index	Parameter	Min	Max	Unit	Default	ID	Description
P3.12.2.8 	Sleep Delay 1	0	3000	s	0	1017	The minimum quantity of time during which the frequency has to stay below the sleep level before the drive stops.
P3.12.2.9 	Wake-up Level 1	0.01	100	x	0	1018	If the PID controller is in sleep mode, it starts the drive and regulates when it goes below this level. Absolute level or relative to the setpoint based on WakeUpMode parameter.
P3.12.2.10	Setpoint 1 Wake-up Mode	0	1		0	15539	The selection for the operation of P3.12.2.9. 0 = Absolute level 1 = Relative setpoint
P3.12.2.11	Setpoint 1 boost	-2.0	2.0	x	1.0	1071	It is possible to boost the setpoint with a digital input.
P3.12.2.12	Setpoint source 2 selection	0	16		2	431	See P3.12.2.4.
P3.12.2.13	Setpoint 2 minimum	-200.00	200.00	%	0.00	1073	The minimum value at the analogue signal minimum.
P3.12.2.14	Setpoint 2 maximum	-200.00	200.00	%	100.00	1074	The maximum value at the analogue signal maximum.
P3.12.2.15	Sleep Frequency limit 2	0.00	320.00	Hz	0.00	1075	See P3.12.2.7.
P3.12.2.16	Sleep Delay 2	0	3000	s	0	1076	See P3.12.2.8.
P3.12.2.17	Wake-up Level 2			Varies	0.0000	1077	See P3.12.2.8.
P3.12.2.18	Setpoint 2 Wake-up mode	0	1		0	15540	The selection for the operation of P3.12.2.17. 0 = Absolute level 1 = Relative setpoint
P3.12.2.19	Setpoint 2 boost	-2.0	2.0	x	1.0	1078	See P3.12.2.11.

Table 34: Feedback settings

Index	Parameter	Min	Max	Unit	Default	ID	Description
P3.12.3.1	Feedback Function	1	9		1	333	1 = Only Source1 in use 2 = SQRT(Source1); (Flow=Constant x SQRT(Pressure)) 3 = SQRT(Source1- Source 2) 4 = SQRT(Source 1) + SQRT (Source 2) 5 = Source 1 + Source 2 6 = Source 1 - Source 2 7 = MIN (Source 1, Source 2) 8 = MAX (Source 1, Source 2) 9 = MEAN (Source 1, Source 2)
P3.12.3.2	Feedback Function Gain	-1000.0	1000.0	%	100.0	1058	Used for example with the value 2 in Feedback Function.

Table 34: Feedback settings

Index	Parameter	Min	Max	Unit	Default	ID	Description
P3.12.3.3	Feedback 1 Source Selection	0	14		2	334	<p>0 = Not used 1 = AI1 2 = AI2 3 = AI3 4 = AI4 5 = AI5 6 = AI6 7 = ProcessDataIn1 8 = ProcessDataIn2 9 = ProcessDataIn3 10 = ProcessDataIn4 11 = ProcessDataIn5 12 = ProcessDataIn6 13 = ProcessDataIn7 14 = ProcessDataIn8</p> <p>The AIs and the ProcessDataIn show as percentages (0.00-100.00%) and use the setpoint minimum and maximum for scaling.</p> <p>NOTE!</p> <p>The ProcessDataIn signals use 2 decimals. If temperature inputs are selected, you must set the values of parameters P3.13.1.7 Process Unit Min and P3.13.1.8 Process Unit Max to agree with the scale of the temperature measurement board:</p> <p>ProcessUnitMin = -50 °C ProcessUnitMax = 200 °C</p>
P3.12.3.4	Feedback 1 Minimum	-200.00	200.00	%	0.00	336	The minimum value at the analogue signal minimum.
P3.12.3.5	Feedback 1 Maximum	-200.00	200.00	%	100.00	337	The maximum value at the analogue signal maximum.
P3.12.3.6	Feedback 2 Source Selection	0	14		0	335	See P3.12.3.3.

Table 34: Feedback settings

Index	Parameter	Min	Max	Unit	Default	ID	Description
P3.12.3.7	Feedback 2 Minimum	-200.00	200.00	%	0.00	338	The minimum value at the analogue signal minimum.
M3.12.3.8	Feedback 2 Maximum	-200.00	200.00	%	100.00	339	The maximum value at the analogue signal maximum.

Table 35: Feedforward settings

Index	Parameter	Min	Max	Unit	Default	ID	Description
P3.12.4.1 	Feedforward Function	1	9		1	1059	See P3.12.3.1
P3.12.4.2	Feedforward Function Gain	-1000	1000	%	100.0	1060	See P3.12.3.2
P3.12.4.3	Feedforward 1 Source Selection	0	14		0	1061	See P3.12.3.3
P3.12.4.4	Feedforward 1 Minimum	-200.00	200.00	%	0.00	1062	See P3.12.3.4
P3.12.4.5	Feedforward 1 Maximum	-200.00	200.00	%	100.00	1063	See P3.12.3.5
P3.12.4.6	Feedforward 2 Source Selection	0	14		0	1064	See P3.12.3.6
P3.12.4.7	Feedforward 2 Min	-200.00	200.00	%	0.00	1065	See P3.12.3.7
P3.12.4.8	Feedforward 2 Max	-200.00	200.00	%	100.00	1066	See M3.12.3.8

Table 36: Process supervision parameters



Index	Parameter	Min	Max	Unit	Default	ID	Description
P3.12.5.1 	Enable Process Supervision	0	1		0	735	0 = Disabled 1 = Enabled
P3.12.5.2	Upper Limit	Varies	Varies	Varies	Varies	736	The supervision of the upper actual/process value.
P3.12.5.3	Lower Limit	Varies	Varies	Varies	Varies	758	The supervision of the lower actual/process value.
P3.12.5.4	Delay	0	30000	s	0	737	If the target value is not reached in this time, a fault or alarm shows.

Table 37: Pressure loss compensation parameters

Index	Parameter	Min	Max	Unit	Default	ID	Description
P3.12.6.1 	Enable Setpoint 1	0	1		0	1189	Enables pressure loss compensation for the setpoint 1. 0 = Disabled 1 = Enabled
P3.12.6.2 	Setpoint 1 Max Compensation	Varies	Varies	Varies	Varies	1190	The value that is added proportionally to the frequency. Setpoint compensation = max compensation * (Freq-Out-MinFreq)/(Max-Freq-MinFreq).
P3.12.6.3	Enable Setpoint 2	0	1		0	1191	See P3.12.6.1.
P3.12.6.4	Setpoint 2 Max Compensation	Varies	Varies	Varies	Varies	1192	See P3.12.6.2.

5.13 GROUP 3.13: PID-CONTROLLER 2

Table 38: Basic settings

Index	Parameter	Min	Max	Unit	Default	ID	Description
P3.13.1.1	Enable PID	0	1		0	1630	0 = Disabled 1 = Enabled
P3.13.1.2	Output in Stop	0.0	100.0	%	0.0	1100	The output value of the PID controller as a percentage of its maximum output value when it is stopped from a digital output.
P3.13.1.3	PID Gain	0.00	1000.00	%	100.00	1631	
P3.13.1.4	PID Integration Time	0.00	600.00	s	1.00	1632	
P3.13.1.5	PID Derivation Time	0.00	100.00	s	0.00	1633	
P3.13.1.6	Process Unit Selection	0	40		0	1635	
P3.13.1.7	Process Unit Min	Varies	Varies	Varies	0	1664	
P3.13.1.8	Process Unit Max	Varies	Varies	Varies	100	1665	
P3.13.1.9	Process Unit Decimals	0	4		2	1666	
P3.13.1.10	Error Inversion	0	1		0	1636	
P3.13.1.11	Dead Band hysteresis	Varies	Varies	Varies	0.0	1637	
P3.13.1.12	Dead Band Delay	0.00	320.00	s	0.00	1638	

Table 39: Setpoints

Index	Parameter	Min	Max	Unit	Default	ID	Description
P3.13.2.1	Keypad Setpoint 1	0.00	100.00	Varies	0.00	1640	
P3.13.2.2	Keypad Setpoint 2	0.00	100.00	Varies	0.00	1641	
P3.13.2.3	Setpoint Ramp Time	0.00	300.00	s	0.00	1642	
P3.13.2.4	Setpoint Source 1 Selection	0	16		1	1643	<p>0 = Not Used 1 = Keypad Setpoint 1 2 = Keypad Setpoint 2 3 = AI1 4 = AI2 5 = AI3 6 = AI4 7 = AI5 8 = AI6 9 = ProcessDataIn1 10 = ProcessDataIn2 11 = ProcessDataIn3 12 = ProcessDataIn4 13 = ProcessDataIn5 14 = ProcessDataIn6 15 = ProcessDataIn7 16 = ProcessDataIn8</p> <p>The AIs and the ProcessDataIn show as percentages (0.00-100.00%) and use the setpoint minimum and maximum for scaling.</p> <p>NOTE!</p> <p>The ProcessDataIn signals use 2 decimals. If temperature inputs are selected, you must set the values of parameters P3.14.1.8 Process Unit Max and P3.14.1.9 Process Unit Min to agree with the scale of the temperature measurement board:</p> <p>ProcessUnitMin = -50 °C ProcessUnitMax = 200 °C</p>

Table 39: Setpoints

Index	Parameter	Min	Max	Unit	Default	ID	Description
P3.13.2.5	Setpoint 1 minimum	-200.00	200.00	%	0.00	1644	The minimum value at the analogue signal minimum.
P3.13.2.6	Setpoint 1 maximum	-200.00	200.00	%	100.00	1645	The maximum value at the analogue signal maximum.
P3.13.2.7	Setpoint source 2 selection	0	16		0	1646	See P3.13.2.4.
P3.13.2.8	Setpoint 2 minimum	-200.00	200.00	%	0.00	1647	The minimum value at the analogue signal minimum.
P3.13.2.9	Setpoint 2 maximum	-200.00	200.00	%	100.00	1648	The maximum value at the analogue signal maximum.

Table 40: Feedbacks

Index	Parameter	Min	Max	Unit	Default	ID	Description
P3.13.3.1	Feedback Function	1	9		1	1650	
P3.13.3.2	Feedback Function Gain	-1000.0	1000.0	%	100.0	1651	
P3.13.3.3	Feedback 1 Source Selection	0	14		1	1652	
P3.13.3.4	Feedback 1 Minimum	-200.00	200.00	%	0.00	1653	The minimum value at the analogue signal minimum.
P3.13.3.5	Feedback 1 Maximum	-200.00	200.00	%	100.00	1654	The maximum value at the analogue signal maximum.
P3.13.3.6	Feedback 2 Source Selection	0	14		2	1655	
P3.13.3.7	Feedback 2 Minimum	-200.00	200.00	%	0.00	1656	The minimum value at the analogue signal minimum.
P3.13.3.8	Feedback 2 Maximum	-200.00	200.00	%	100.00	1657	The maximum value at the analogue signal maximum.

Table 41: Process supervision

Index	Parameter	Min	Max	Unit	Default	ID	Description
P3.13.4.1	Enable Supervision	0	1		0	1659	0 = Disabled 1 = Enabled
P3.13.4.2	Upper Limit	Varies	Varies	Varies	Varies	1660	
P3.13.4.3	Lower Limit	Varies	Varies	Varies	Varies	1661	
P3.13.4.4	Delay	0	30000	s	0	1662	If the target value is not reached in this time, a fault or an alarm shows.

5.14 GROUP 3.14: MULTIPUMP

Table 42: Multipump parameters



Index	Parameter	Min	Max	Unit	Default	ID	Description
P3.14.1	Number of Motors	1	5		1	1001	The quantity of motors (or pumps or fans) that there are in the multi-pump system.
P3.14.2 	Interlock Function	0	1		1	1032	Enable or disable the interlocks. You can use the interlocks to tell the system if a motor is connected. 0 = Disabled 1 = Enabled
P3.14.3 	Include FC	0	1		1	1028	Include the AC drive in the autochange and interlock system. 0 = Disabled 1 = Enabled
P3.14.4 	Autochange	0	1		1	1027	Enable or disable the rotation of the start sequence and the priority of motors. 0 = Disabled 1 = Enabled
P3.14.5	Autochange Interval	0.0	3000.0	h	48.0	1029	When this time is over, the autochange occurs if the capacity is below the level set with P3.14.6. and P3.14.7.
P3.14.6	Autochange: Frequency Limit	0.00	50.00	Hz	25.00	1031	These parameters define the level below which the capacity must stay for the autochange to occur.
P3.14.7	Autochange: Motor Limit	0	4		1	1030	
P3.14.8	Bandwidth	0	100	%	10	1097	The percentage of the setpoint. For example, if setpoint = 5 bar, bandwidth = 10%. When the feedback value stays between 4.5 and 5.5 bar, the motor is not disconnected or removed.

Table 42: Multipump parameters

Index	Parameter	Min	Max	Unit	Default	ID	Description
P3.14.9	Bandwidth Delay	0	3600	s	10	1098	If the feedback is outside the bandwidth, this time must be over before you can add or remove pumps.

5.15 GROUP 3.16: FIRE MODE

Table 43: Fire mode parameters

Index	Parameter	Min	Max	Unit	Default	ID	Description
P3.16.1	Fire Mode Password	0	9999		0	1599	1002 = Enabled 1234 = Test mode
P3.16.2	Fire Mode Activ. Open				DigIN Slot0.2	1596	Open = Fire Mode active closed = No action
P3.16.3	Fire Mode Activ. Close				DigIN Slot0.1	1619	Open = No action Closed = Fire Mode active
P3.16.4	Fire Mode Frequency	8.00	P3.3.2	Hz	0.00	1598	The frequency that is used when Fire mode is active.
P3.16.5	Fire Mode Frequency Source	0	8		0	1617	Selection of the fre- quency reference source when Fire mode is active. This enables the selection of for example the AI1 or the PID controller as the reference source when you operate Fire Mode. 0 = Fire Mode fre- quency 1 = Preset speeds 2 = Keypad 3 = Fieldbus 4 = AI1 5 = AI2 6 = AI1 + AI2 7 = PID1 8 = Motor potentiome- ter
P3.16.6	Fire Mode Reverse				DigIN Slot0.1	1618	The command of the reverse rotation direc- tion during Fire mode. This function has no effect in normal opera- tion. Open = Forward Closed = Reverse

Table 43: Fire mode parameters

Index	Parameter	Min	Max	Unit	Default	ID	Description
P3.16.7	Fire Mode preset frequency 1	0	50		10	15535	Preset frequency for Fire Mode.
P3.16.8	Fire Mode preset frequency 2	0	50		20	15536	See above.
P3.16.9	Fire Mode preset frequency 3	0	50		30	15537	See above.
M3.16.10	Fire Mode Status	0	3		0	1597	A monitoring value. See 4.1.2 Basic. 0 = Disabled 1 = Enabled 2 = Activated (Enabled + DI Open) 3 = Test Mode
M3.16.11	Fire Mode Counter				0	1679	Shows how many times Fire mode has been activated in the enabled mode. You cannot reset this counter.
P3.16.12 	Fire Mode Run Indication Current	0.0	100.0	%	20.0	15580	The current limit for the run indication signal of the digital output.

5.16 GROUP 3.17: APPLICATION SETTINGS

Table 44: Application settings

Index	Parameter	Min	Max	Unit	Default	ID	Description
P3.17.1	Password	0	9999		0	1806	
P3.17.2	°C / °F selection			°C		1197	A selection for the panel to show the temperatures as degree Celsius or degree Fahrenheit.
P3.17.3	kW/HP selection			kW		1198	A selection for the panel to show the motor shaft power in kW or in Hp.
P3.17.4	FunctButtonConfig	0	7		3	1195	This parameter determines which selections are visible when you press the function button.

5.17 GROUP 3.18: KWH PULSE OUTPUT SETTINGS

Table 45: kWh pulse output settings

Index	Parameter	Min	Max	Unit	Default	ID	Description
P3.18.1	kWh pulse length	50	200	ms	50	15534	The length of the kWh pulse in milliseconds.
P3.18.2	kWh pulse resolution	1	100	kWh	1	15533	Indicates how often the kWh pulse must be triggered.

6 DIAGNOSTICS MENU

6.1 ACTIVE FAULTS

When there is a fault or many faults, the display shows the name of the fault and blinks. Push OK to go back to the Diagnostics menu. The submenu Active faults shows the number of faults. To see the fault-time data, make a selection of a fault and push OK.

The fault stays active until you reset it. There are 5 ways to reset a fault.

- Push the Reset button for 2 s.
- Go into the submenu Reset faults and use the parameter Reset Faults.
- Give a reset signal in the I/O terminal.
- Give a reset signal with the fieldbus.
- Give a reset signal in Vacon Live.

The Active faults submenu can keep a storage of maximum 10 faults. The submenu shows the faults in the sequence in which they occurred.

6.2 RESET FAULTS

In this menu, you can reset faults. See instructions in Chapter 10.1 *A fault comes into view*.



CAUTION!

Before you reset the fault, remove the external Control signal to prevent that you restart the drive accidentally.

6.3 FAULT HISTORY

You can see 40 faults in the Fault history.

To see the details of a fault, go into Fault history, find the fault and push OK.

6.4 TOTAL COUNTERS

Table 46: The total counter parameters in the diagnostics menu

Index	Parameter	Min	Max	Unit	Default	ID	Description
V4.4.1	Energy Counter			Varies		2291	The quantity of energy taken from the supply network. You cannot reset the counter. In the text display: the highest energy unit that the display shows is MW. If the counted energy becomes more than 999.9 MW, no unit shows on the display.
V4.4.3	Operating Time (graphical keypad)			a d hh:min		2298	The operating time of the control unit.
V4.4.4	Operating Time (text keypad)			a			The operating time of the control unit in total years.
V4.4.5	Operating Time (text keypad)			d			The operating time of the control unit in total days.
V4.4.6	Operating Time (text keypad)			hh:min: ss			The operating time of the control unit in hours, minutes and seconds.
V4.4.7	Run Time (graphical keypad)			a d hh:min		2293	The motor run time.
V4.4.8	Run Time (text keypad)			a			The motor run time in total years.
V4.4.9	Run Time (text keypad)			d			The motor run time in total days.
V4.4.10	Run Time (text keypad)			hh:min: ss			The motor run time in hours, minutes and seconds.
V4.4.11	Power On Time (graphical keypad)			a d hh:min		2294	The quantity of time that the power unit has been powered on. You cannot reset the counter.
V4.4.12	Power On Time (text keypad)			a			The power on time in total years.
V4.4.13	Power On Time (text keypad)			d			The power on time in total days.

Table 46: The total counter parameters in the diagnostics menu

Index	Parameter	Min	Max	Unit	Default	ID	Description
V4.4.14	Power On Time (text keypad)			hh:min:ss			The power on time in hours, minutes and seconds.
V4.4.15	Start Command Counter					2295	The number of times that the power unit has been started.

6.5 TRIP COUNTERS

Table 47: The trip counter parameters in the diagnostics menu

Index	Parameter	Min	Max	Unit	Default	ID	Description
P4.5.1	Energy Trip Counter			Varies		2296	<p>You can reset this counter. In the text display: the highest energy unit that the display shows is MW. If the counted energy becomes more than 999.9 MW, no unit shows on the display.</p> <p>Resetting the counter</p> <ul style="list-style-type: none"> In the text display: Push the OK button for 4 s. In the graphical display: Push OK. A Reset counter page shows. Push OK again.
P4.5.3	Operating Time (graphical keypad)			a d hh:min		2299	You can reset this counter. See instructions in P4.5.1 above.
P4.5.4	Operating Time (text keypad)			a			The operating time in total years.
P4.5.5	Operating Time (text keypad)			d			The operating time in total days.
P4.5.6	Operating Time (text keypad)			hh:min:ss			The operating time in hours, minutes and seconds.

6.6 SOFTWARE INFO

Table 48: The software info parameters in the diagnostics menu

Index	Parameter	Min	Max	Unit	Default	ID	Description
V4.6.1	Software Package (graphical keypad)					2524	The code for the software identification
V4.6.2	Software Package ID (text keypad)						
V4.6.3	Software Package Version (text keypad)						
V4.6.4	System Load	0	100	%		2300	The load on the control unit CPU
V4.6.5	Application Name (graphical keypad)					2525	The name of the application
V4.6.6	Application ID					837	The code of the application
V4.6.7	Application Version					838	

7 I/O AND HARDWARE MENU

In this menu, there are different settings that are related to the options.

7.1 BASIC I/O

In the Basic I/O menu, you can monitor the statuses of the inputs and the outputs.

Table 49: The basic I/O parameters in the I/O and Hardware menu

Index	Parameter	Min	Max	Unit	Default	ID	Description
V5.1.1	Digital Input 1	0	1		0		Status of the digital input signal
V5.1.2	Digital Input 2	0	1		0		Status of the digital input signal
V5.1.3	Digital Input 3	0	1		0		Status of the digital input signal
V5.1.4	Digital Input 4	0	1		0		Status of the digital input signal
V5.1.5	Digital Input 5	0	1		0		Status of the digital input signal
V5.1.6	Digital Input 6	0	1		0		Status of the digital input signal
V5.1.7	Analogue Input 1 Mode	1	3		3		Shows the mode that is set for the analogue input signal. The selection is made with a DIP switch on the control board. 1 = 0...20mA 3 = 0...10V
V5.1.8	Analogue Input 1	0	100	%	0.00		Status of the analogue input signal
V5.1.9	Analogue Input 2 Mode	1	3		3		Shows the mode that is set for the analogue input signal. The selection is made with a DIP switch on the control board. 1 = 0...20mA 3 = 0...10V
V5.1.10	Analogue Input 2	0	100	%	0.00		Status of the analogue input signal

Table 49: The basic I/O parameters in the I/O and Hardware menu

Index	Parameter	Min	Max	Unit	Default	ID	Description
V5.1.11	Analogue Output 1 Mode	1	3		1		Shows the mode that is set for the analogue input signal. The selection is made with a DIP switch on the control board. 1 = 0...20mA 3 = 0...10V
V5.1.12	Analogue Output 1	0	100	%	0.00		Status of the analogue output signal
V5.1.13	Relay Output 1	0	1		0		Status of the relay output signal
V5.1.14	Relay Output 2	0	1		0		Status of the relay output signal
V5.1.15	Relay Output 3	0	1		0		Status of the relay output signal

7.2 OPTION BOARD SLOTS

The parameters in this menu are different for all the option boards. You see the parameters of the option board that you installed. If there is no option board in the slots C, D or E, you do not see parameters. See more about the location of the slots in Chapter 9.5 *I/O configuration*.

When you remove an option board, the fault code 39 and the fault name *Device removed* show on the display. See Chapter 10.3 *Fault codes*.

Table 50: Option board related parameters

Menu	Function	Description
Slot C	Settings	The settings that are related to the option board
	Monitoring	Monitor the data that is related to the option board
Slot D	Settings	The settings that are related to the option board
	Monitoring	Monitor the data that is related to the option board
Slot E	Settings	The settings that are related to the option board
	Monitoring	Monitor the data that is related to the option board

7.3 REAL TIME CLOCK

Table 51: The real time clock parameters in the I/O and Hardware menu

Index	Parameter	Min	Max	Unit	Default	ID	Description
V5.5.1	Battery State	1	3			2205	Status of the battery. 1 = Not installed 2 = Installed 3 = Replace the battery
P5.5.2	Time			hh:mm:ss		2201	The current time of the day
P5.5.3	Date			dd.mm.		2202	The current date
P5.5.4	Year			yyyy		2203	The current year
P5.5.5	Daylight Saving	1	4		1	2204	The daylight saving rule 1 = Off 2 = EU: starts on the last Sunday in March, ends on the last Sunday in October 3 = US: starts on the 2nd Sunday in March, ends on the 1st Sunday in November 4 = Russia (permanent)

7.4 POWER UNIT SETTINGS

In this menu, you can change the settings of the fan and the sine filter.

The fan operates in the optimised or the always on mode. In the optimised mode, the internal logic of the drive receives data about the temperature and controls the fan speed. After the drive goes in the Ready state, the fan stops in 5 minutes. In the always on mode, the fan operates in full speed, and does not stop.

The Sine filter keeps the overmodulation depth in limits and does not let the thermal management functions decrease the switching frequency.

Table 52: Power unit settings, Fan

Index	Parameter	Min	Max	Unit	Default	ID	Description
V5.5.1.1	Fan Control Mode	0	1		1	2377	0 = Always on 1 = Optimised
M5.6.1.5	Fan lifetime	N/A	N/A			849	Fan lifetime
M5.6.1.6	Fan lifetime alarm limit	0	200 000	h	50 000	824	Fan lifetime alarm limit
M5.6.1.7	Fan lifetime reset	N/A	N/A		0	823	Fan lifetime reset

Table 53: Power unit settings, Sine filter

Index	Parameter	Min	Max	Unit	Default	ID	Description
P5.6.4.1	Sine Filter	0	1		0	2507	0 = Not used 1 = In use

7.5 KEYPAD

Table 54: The keypad parameters in the I/O and Hardware menu

Index	Parameter	Min	Max	Unit	Default	ID	Description
P5.7.1	Timeout Time	0	60	min	0	804	The time after which the display goes back to the page that is set with parameter P5.7.2. 0 = Not used
P5.7.2	Default Page	0	4		0	2318	0 = None 1 = Enter menu index 2 = Main menu 3 = Control page 4 = Multimonitor
P5.7.3	Menu Index					2499	Set a page to be the menu index. (The selection 1 in P5.7.2.)
P5.7.4	Contrast *	30	70	%	50	830	Set the contrast of the display.
P5.7.5	Backlight Time	0	60	min	5	818	Set the time after which the backlight of the display turns off. If the value is set to 0, the backlight is always on.

* Only available with the graphical keypad.

7.6 FIELDBUS

In the I/O and Hardware menu, there are the parameters that are related to different fieldbus boards. You can find the instructions on how to use these parameters in the related fieldbus manual.

8 USER SETTINGS, FAVOURITES AND USER LEVEL MENUS

8.1 USER SETTINGS

Table 55: General settings in the user settings menu

Index	Parameter	Min	Max	Unit	Default	ID	Description
P6.1	Language selection	Varies	Varies		Varies	802	The selection is different in all the language packages
M6.5	Parameter backup						See Table 56 The parameter backup parameters in the user settings menu.
M6.6	Parameter compare						
P6.7	Drive name						Use Vacon Live PC tool to give a name to the drive if you think that it is necessary.

8.1.1 PARAMETER BACKUP

Table 56: The parameter backup parameters in the user settings menu

Index	Parameter	Min	Max	Unit	Default	ID	Description
P6.5.1	Restore Factory Defaults					831	Restores the default parameter values and starts the Startup wizard.
P6.5.2	Save to Keypad *					2487	Saves the parameter values to the control panel, for example to copy them to another drive.
P6.5.3	Restore from Keypad *					2488	Loads the parameter values from the control panel to the drive.
P6.5.4	Save to Set 1						Keeps the parameter values to the parameter set 1.
P6.5.5	Restore from Set 1						Loads the parameter values from the parameters set 1 to the drive.
P6.5.6	Save to Set 2						Keeps the parameter values to the parameter set 2.
P6.5.7	Restore from Set 2						Loads the parameter values from the parameter set 2 to the drive.

* Only available with the graphical display.

Table 57: The parameter compare

Index	Parameter	Min	Max	Unit	Default	ID	Description
P6.6.1	Active set-Set 1					2493	Starts to compare parameters to the selected set.
P6.6.2	Active set-Set 2					2494	Starts to compare parameters to the selected set.
P6.6.3	Active set-Defaults					2495	Starts to compare parameters to the selected set.
P6.6.4	Active set-Keypad set					2496	Starts to compare parameters to the selected set.

8.2 FAVOURITES



NOTE!

This menu is not available in the text display.

If you use the same items frequently, you can add them into Favourites. You can collect a set of parameters or monitoring signals from all the keypad menus. It is not necessary to find them in the menu structure one by one. As an alternative, add them into the Favourites folder where it is easy to find them.

ADDING AN ITEM TO THE FAVOURITES

- 1 Find the item that you want to add to Favourites. Push the OK button.

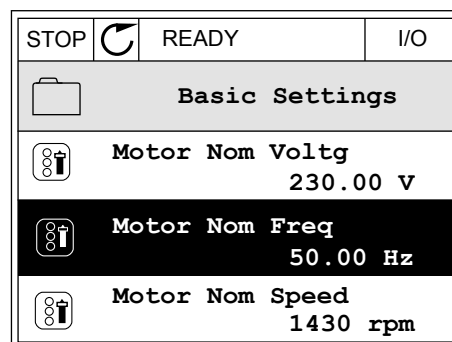

- 2 Make a selection of *Add to favourites* and push the OK button.

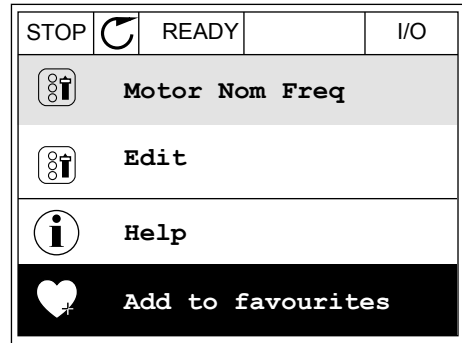

- 3 The steps are now completed. To continue, read the instructions on the display.

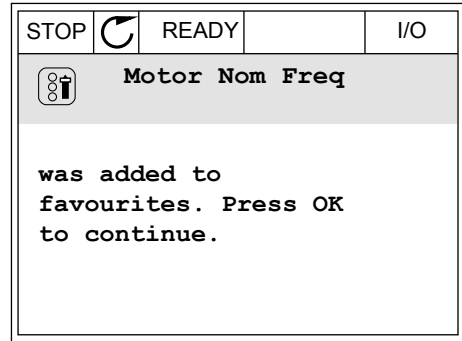

REMOVING AN ITEM FROM THE FAVOURITES

- 1 Go to the Favourites.
- 2 Find the item that you want to remove. Push the OK button.

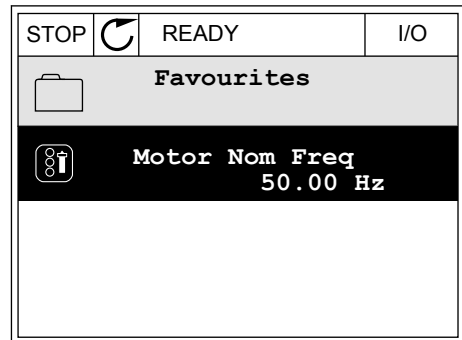

- 3 Make a selection of *Rem from favourites*.

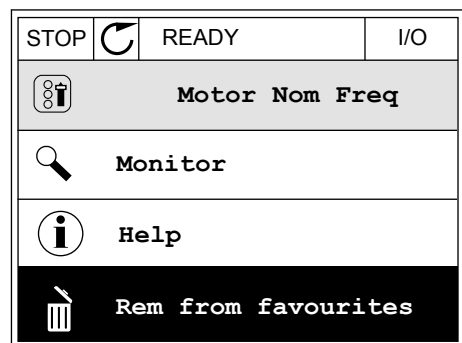

- 4 To remove the item, push the OK button again.

8.3 USER LEVELS

Use the User level parameters to keep the personnel who are not approved from making changes in the parameters. You can also prevent accidental changes in the parameters.

When you make a selection of a user level, the user cannot see all the parameters on the display of the control panel.

Table 58: The user level parameters

Index	Parameter	Min	Max	Unit	Default	ID	Description
P8.1	User Level	0	1		0	1194	0 = Normal. 1 = Monitoring. Only the monitoring, favourites and user level menus are visible in the main menu.
P8.2	Access Code	0	9		0	2362	If you set the value to be to other than 0 before you go to <i>Monitoring</i> from, for example, <i>Normal</i> , you have to give the access code when you go back to <i>Normal</i> . This prevents personnel who are not approved from making changes in the parameters on the control panel.



CAUTION!

Do not lose the access code. If the access code is lost, contact your nearest service center or partner.

CHANGING THE ACCESS CODE OF THE USER LEVELS

- 1 Go to the User levels.
- 2 Go to the item Access code and push the arrow button Right.

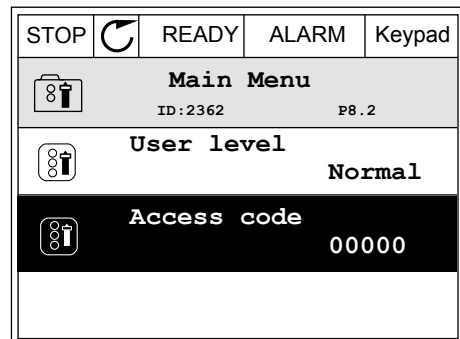

- To change the digits of the access code, use all the arrow buttons.

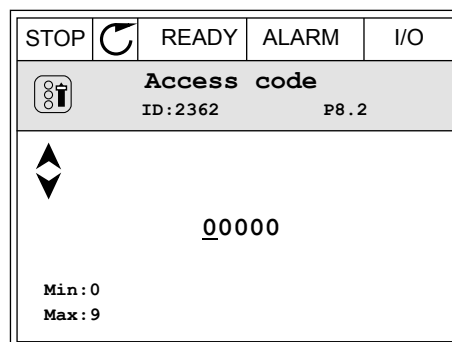

- Accept the change with the OK button.

9 PARAMETER DESCRIPTIONS

In this chapter, you can find data on the most special parameters of the application. For most parameters of the Vacon 100 application, a basic description is sufficient. You can find these basic descriptions in the parameter tables of Chapter 5 *Parameters menu*. If other data is necessary, your distributor will help you.

9.1 MOTOR SETTINGS

P3.1.1.7 MOTOR CURRENT LIMIT (ID107)

This parameter tells the maximum motor current from the AC drive. The range of values for the parameter is different for each frame size of the drive.

When the current limit is active, the drive output frequency is decreases.



NOTE!

The Motor Current Limit is not an overcurrent trip limit.

P3.1.2.9 U/F RATIO SELECTION (ID108)

Selection number	Selection name	Description
0	Linear	The voltage of the motor changes linearly as a function of the output frequency. The voltage changes from the value of P3.1.2.4 (Zero Frequency Voltage) to the value of Voltage at Field Weakening Point at a frequency set in Field Weakening Point Frequency. Use this default setting if a different setting is not necessary.
1	Squared	The voltage of the motor changes from the value of P3.1.2.4 (Zero Frequency Voltage) to the value of Field Weakening Point Frequency at a squared curve. The motor operates undermagnetised below the field weakening point and produces less torque. You can use the squared U/f ratio in applications where the torque demand is in relation to the square of the speed, for example in centrifugal fans and pumps.

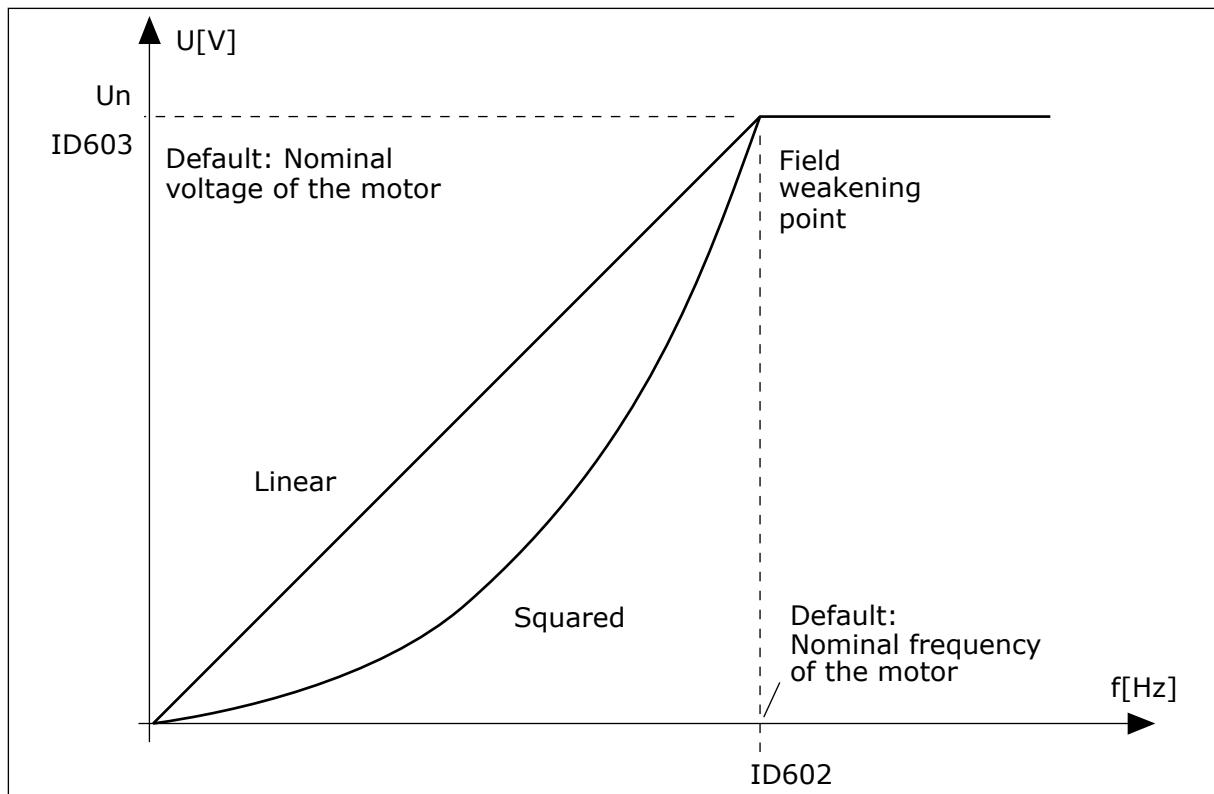

Fig. 12: Linear and squared change of the motor voltage

P3.1.2.15 OVERVOLTAGE CONTROL (ID607)

See the description in P3.1.2.16 Undervoltage Control.

P3.1.2.16 UNDERVOLTAGE CONTROLLER (ID608)

When you enable P3.1.2.15 or P3.1.2.16, the controllers start to monitor the changes in the supply voltage. The controllers change the output frequency if it becomes too high or too low.

To stop the operation of the undervoltage and the overvoltage controllers, disable these 2 parameters. This is useful if the supply voltage changes more than -15% to +10%, and if the application does not tolerate the operation of the controllers.

P3.1.2.17 STATOR VOLTAGE ADJUST (ID659)

It is possible to use this parameter only when the parameter P3.1.1.8 Motor Type has the value *PM motor*. If you set *induction motor* as the motor type, the value is automatically set to 100%, and you cannot change the value.

When you change the value of P3.1.1.8 (Motor type) to *PM Motor*, the U/f curve will increase automatically to be equal with output voltage of the drive. The set U/f ratio does not change. This is done to prevent the operation of the PM motor in the field weakening area. The nominal voltage of the PM motor is much lower than the full output voltage of the drive.

The nominal voltage of the PM motor agrees to the back-EMF voltage of the motor at nominal frequency. But in a different motor manufacturer, it can be equal to, for example, the stator voltage at nominal load.

Stator Voltage Adjust helps you to adjust the U/f curve of the drive near the back-EMF curve. It is not necessary to change the values of many U/f curve parameters.

The parameter P3.1.2.17 gives the output voltage of the drive in percentage of the nominal voltage of the motor at the nominal frequency of the motor. Adjust the U/f curve of the drive above the back-EMF curve of the motor. The motor current increases the more the U/f curve is different from the back-EMF curve.

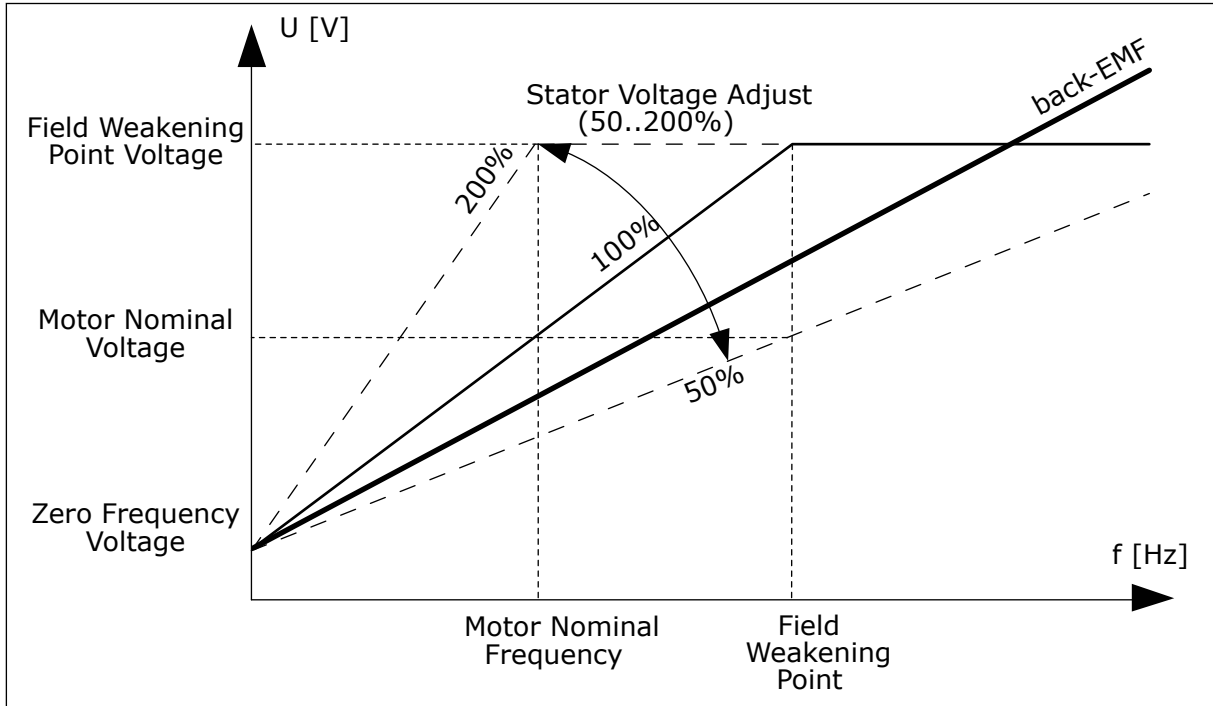

Fig. 13: The stator voltage adjustment

9.2 START/STOP SETUP

P3.2.5 STOP FUNCTION (ID 506)

Use this parameter to select the type of the stop function.

Selection number	Selection name	Description
0	Coasting	The motor stops on its inertia. When the stop command is given, the control by the drive stops and the current from the drive goes to 0.
1	Ramp	After the stop command, the speed of the motor is decreased to zero speed according to the deceleration parameters.

P3.2.6 I/O START/STOP LOGIC (ID300)

It is possible to control the start and stop of the drive with the digital signals in this parameter.

The selections that include the word edge help you to prevent an accidental start.

An accidental start can occur, for example, in these conditions

- When you connect the power.
- When the power is connected again after a power cut.
- After you reset a fault.
- After Run Enable stops the drive.
- When you change the control place to I/O control.

Before you can start the motor, you must open the Start/Stop contact.

In all the examples of the next pages, the stop mode is coasting. CS = Control signal.

Selection number	Selection name	Description
0	CS1 = Forward CS2 = Backward	The functions activate when the contacts are closed.

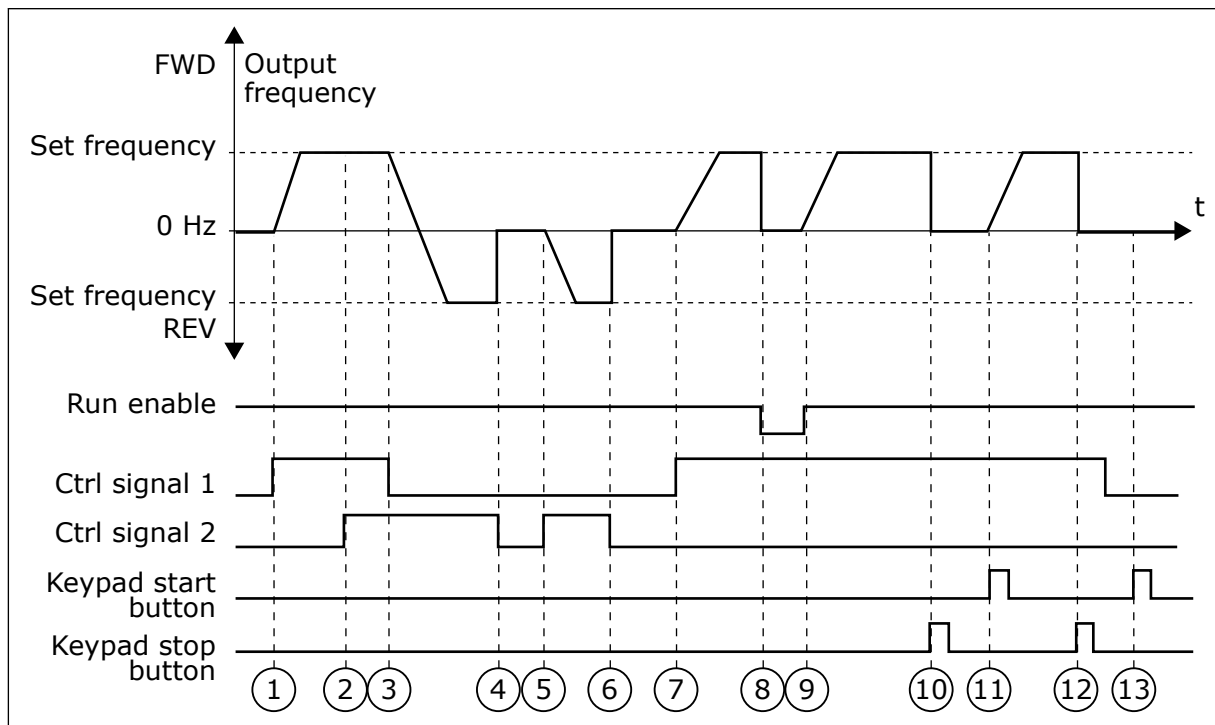

Fig. 14: I/O A Start/stop logic = 0

1. Control signal (CS) 1 activates and causes the output frequency to increase. The motor operates forward.
2. CS2 activates, but it does not have an effect on the output frequency, because the direction that is set first has the highest priority.
3. CS1 becomes inactive and causes the direction to start to change (FWD to REV), because CS2 is still active.
4. CS2 becomes inactive and the frequency that is fed to the motor goes to 0.
5. CS2 activates again and causes the motor to accelerate (REV) to the set frequency.

6. CS2 becomes inactive and the frequency fed to the motor drops to 0.
7. CS1 activates and the motor accelerates (FWD) to the set frequency
8. The Run enable signal is set to OPEN, which causes the frequency to go to 0. Configure the Run enable signal with parameter P3.5.1.10.
9. The Run enable signal is set to CLOSED, which causes the frequency to increase to the set frequency, because CS1 is still active.
10. The STOP button on the keypad is pushed, and the frequency that is fed to the motor goes to 0. (This signal only works if the value of P3.2.3 Keypad Stop Button is Yes.)
11. The drive starts because the START button on the keypad was pushed.
12. The STOP button on the keypad is pushed again to stop the drive.
13. The attempt to start the drive with the START button is not successful, because CS1 is inactive.

Selection number	Selection name	Description
1	CS1 = Forward (edge) CS2 = Inverted stop	

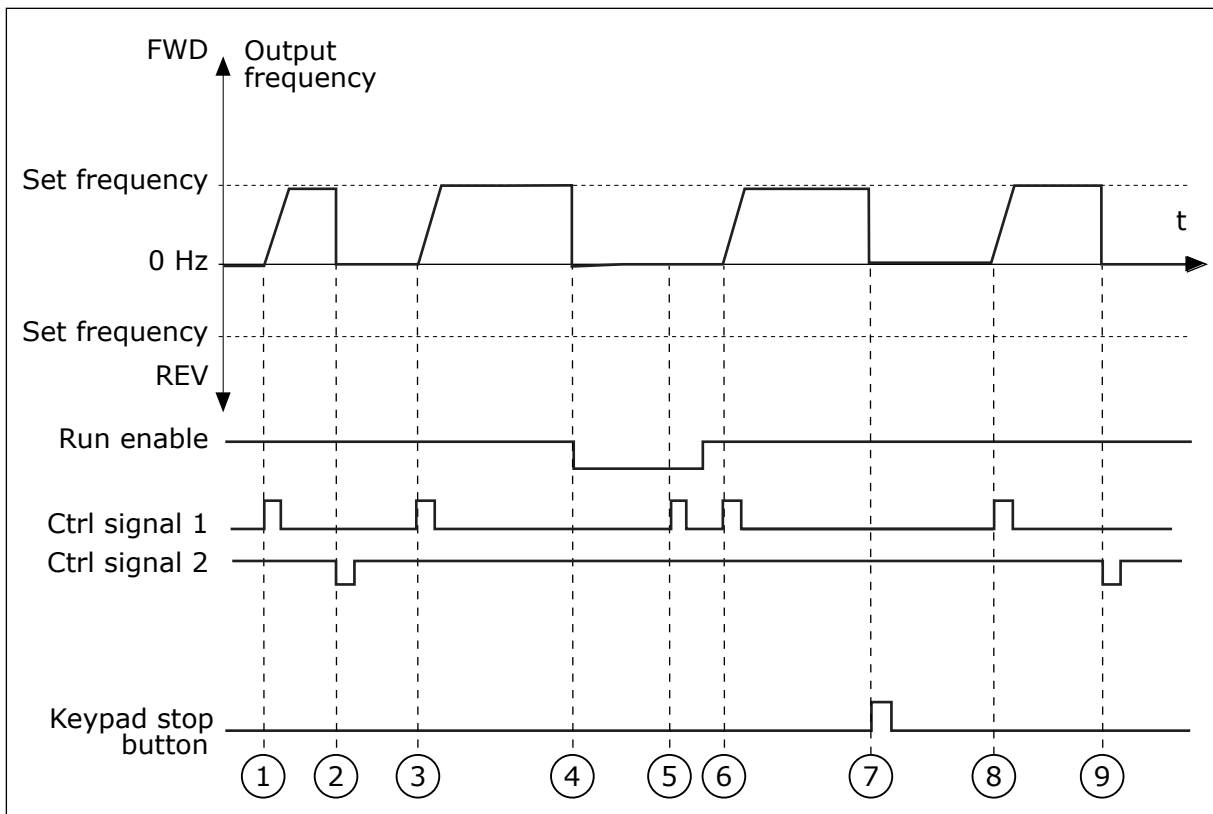

Fig. 15: I/O A Start/stop logic = 1

1. Control signal (CS) 1 activates and causes the output frequency to increase. The motor operates forward.
2. CS2 becomes inactive and causes the frequency to go to 0.
3. CS1 activates and causes the output frequency to increase again. The motor operates forward.

4. The Run enable signal is set to OPEN, which causes the frequency to go to 0. Configure the Run enable signal with parameter 3.5.1.10.
5. The start attempt with CS1 is not successful, because the Run enable signal is still OPEN.
6. CS1 activates and the motor accelerates (FWD) to the set frequency, because the Run enable signal was set to CLOSED.
7. The STOP button on the keypad is pushed, and the frequency that is fed to the motor goes to 0. (This signal only works if the value of P3.2.3 Keypad Stop Button is Yes.)
8. CS1 activates and causes the output frequency to increase again. The motor operates forward.
9. CS2 becomes inactive and causes the frequency to go to 0.

Selection number	Selection name	Description
2	CS1 = Forward (edge) CS2 = Backward (edge)	Use this function to prevent an accidental start. Before you can start the motor again, you must open the start/stop contact.

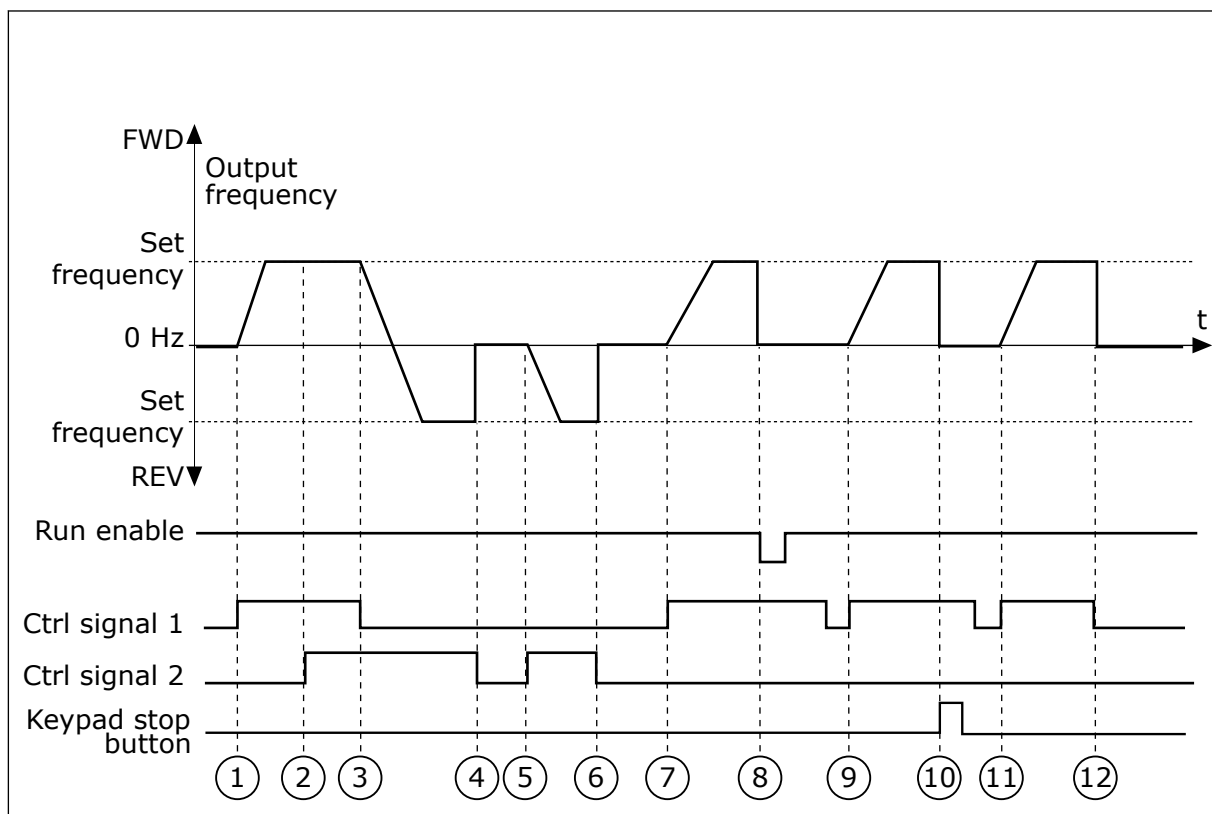

Fig. 16: I/O A Start/stop logic = 2

1. Control signal (CS) 1 activates and causes the output frequency to increase. The motor operates forward.
2. CS2 activates, but it does not have an effect on the output frequency, because the direction that is set first has the highest priority.
3. CS1 becomes inactive and causes the direction to start to change (FWD to REV), because CS2 is still active.
4. CS2 becomes inactive and the frequency that is fed to the motor goes to 0.

5. CS2 activates again and causes the motor to accelerate (REV) to the set frequency.
6. CS2 becomes inactive and the frequency that is fed to the motor goes to 0.
7. CS1 activates and the motor accelerates (FWD) to the set frequency.
8. The Run enable signal is set to OPEN, which causes the frequency to go to 0. Configure the Run enable signal with parameter P3.5.1.10.
9. The Run enable signal is set to CLOSED, which does not have an effect, because a rising edge is necessary for the start, even if CS1 is active.
10. The STOP button on the keypad is pushed and the frequency that is fed to the motor goes to 0. (This signal only works if the value of P3.2.3 Keypad Stop Button is Yes.)
11. CS1 is opened and closed again, which causes the motor to start.
12. CS1 becomes inactive and the frequency that is fed to the motor goes to 0.

Selection number	Selection name	Description
3	CS1 = Start CS2 = Reverse	

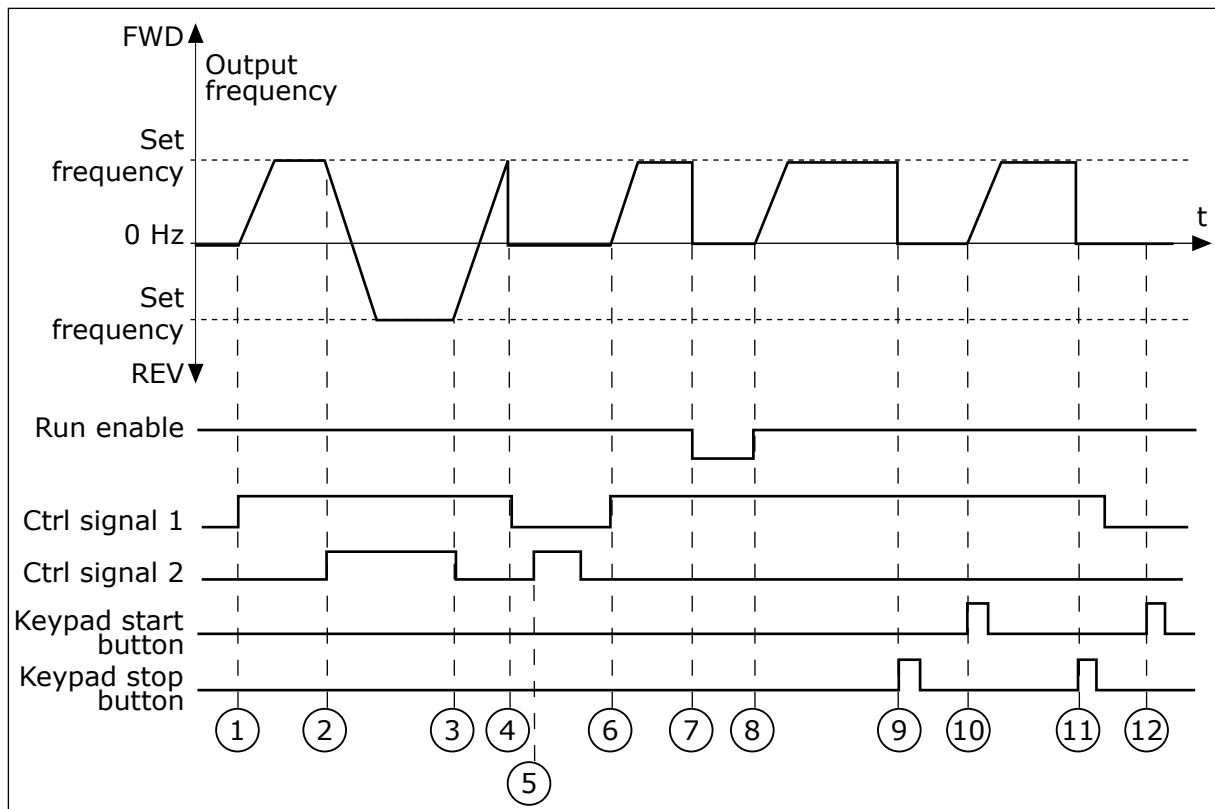

Fig. 17: I/O A Start/stop logic = 3

1. Control signal (CS) 1 activates and causes the output frequency to increase. The motor operates forward.
2. CS2 activates and causes the direction to start to change (FWD to REV).
3. CS2 becomes inactive, which causes the direction to start to change (REV to FWD), because CS1 is still active.
4. CS1 becomes inactive and the frequency goes to 0.
5. CS2 activates, but the motor does not start because CS1 is inactive.
6. CS1 activates and causes the output frequency to increase again. The motor operates forward because CS2 is inactive.
7. The Run enable signal is set to OPEN, which causes the frequency to go to 0. Configure the Run enable signal with parameter P3.5.1.10.
8. The Run enable signal is set to CLOSED, which causes the frequency to increase to the set frequency, because CS1 is still active.
9. The STOP button on the keypad is pushed and the frequency that is fed to the motor goes to 0. (This signal only works if the value of P3.2.3 Keypad Stop Button is Yes.)
10. The drive starts because the START button on the keypad was pushed.
11. The drive is stopped again with the STOP button on the keypad.
12. The attempt to start the drive with the START button is not successful, because CS1 is inactive.

Selection number	Selection name	Description
4	CS1 = Start (edge) CS2 = Reverse	Use this function to prevent an accidental start. Before you can start the motor again, you must open the start/stop contact.

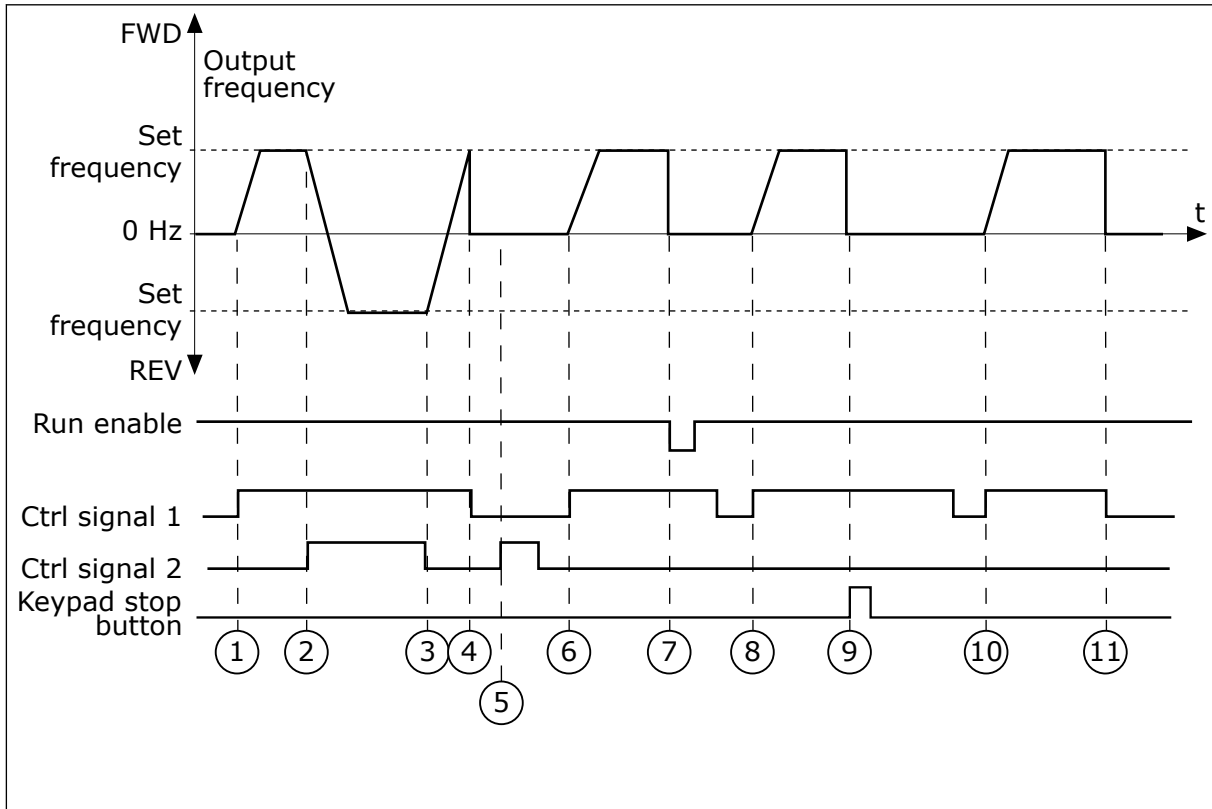

Fig. 18: I/O A Start/stop logic = 4

- Control signal (CS) 1 activates and causes the output frequency to increase. The motor operates forward because CS2 is inactive.
- CS2 activates, which causes the direction to start to change (FWD to REV).
- CS2 becomes inactive, which causes the direction to start to change (REV to FWD), because CS1 is still active.
- CS1 becomes inactive and the frequency goes to 0.
- CS2 activates, but the motor does not start because CS1 is inactive.
- CS1 activates and causes the output frequency to increase again. The motor operates forward, because CS2 is inactive.
- The Run enable signal is set to OPEN, which causes the frequency to go to 0. Configure the Run enable signal with parameter P3.5.1.10.
- Before the drive can start, you must open and close CS1 again.
- The STOP button on the keypad is pushed and the frequency that is fed to the motor goes to 0. (This signal only works if the value of P3.2.3 Keypad Stop Button is Yes.)
- Before the drive can start, you must open and close CS1 again.
- CS1 becomes inactive and the frequency goes to 0.

9.3 REFERENCES

You can use the Preset frequencies function in processes where more than 1 fixed frequency reference is necessary. There are 8 preset frequency references available. You can make the selection of a preset frequency reference with the digital input signals P3.5.1.15, P3.5.1.16, and P3.5.1.17.

P3.3.10 PRESET FREQUENCY MODE (ID182)

With this parameter, you can set the logic which one of the preset frequencies is selected into use. There is a selection of 2 different logics.

Selection number	Selection name	Description
0	Binary coded	The mix of the inputs is binary coded. The different sets of active digital inputs determine the preset frequency. See more data in <i>Table 59 The selection of preset frequencies when P3.3.10 = Binary coded.</i>
1	Number (of inputs used)	The number of active inputs tells which preset frequency is used: 1, 2 or 3.

P3.3.12 PRESET FREQUENCY 1 (ID180)

P3.3.13 PRESET FREQUENCY 2 (ID106)

P3.3.14 PRESET FREQUENCY 3 (ID126)

P3.3.15 PRESET FREQUENCY 4 (ID127)

P3.3.16 PRESET FREQUENCY 5 (ID128)

P3.3.17 PRESET FREQUENCY 6 (ID129)

P3.3.18 PRESET FREQUENCY 7 (ID130)

To make a selection of a preset frequency between 1 and 7, give digital inputs to P3.5.1.15 (Preset Frequency Selection 0), P3.5.1.16 (Preset Frequency Selection 1), and/or P3.5.1.17 (Preset Frequency Selection 2). The different sets of active digital inputs determine the preset frequency. You can find more data in the table below. The values of the preset frequencies stay automatically between the minimum and maximum frequencies (P3.3.1 and P3.3.2).

Necessary step	Activated frequency
Make a selection of the value 1 for parameter P3.3.3.	Preset frequency 0

Table 59: The selection of preset frequencies when P3.3.10 = Binary coded

Activated digital input signal			Activated frequency reference
B2	B1	B0	
			Preset frequency 0
		*	Preset frequency 1
	*		Preset frequency 2
	*	*	Preset frequency 3
*			Preset frequency 4
*		*	Preset frequency 5
*	*		Preset frequency 6
*	*	*	Preset frequency 7

* = the input is activated.

9.4 RAMPS AND BRAKES SETUP

P3.4.1 RAMP 1 SHAPE (ID500)

With the parameter Ramp 1 Shape, you can make smoother the start and the end of the acceleration and deceleration ramps. If you set the value to 0, you get a linear ramp shape. The acceleration and deceleration act immediately to the changes in the reference signal.

When you set the value between 0.1 and 10 s, you get an S-shaped acceleration or deceleration ramp. Use this function to reduce mechanical erosion of the parts and current spikes when the reference changes. You can modify the acceleration time with parameters P3.4.2 (Acceleration Time 1) and P3.4.3 (Deceleration Time 1).

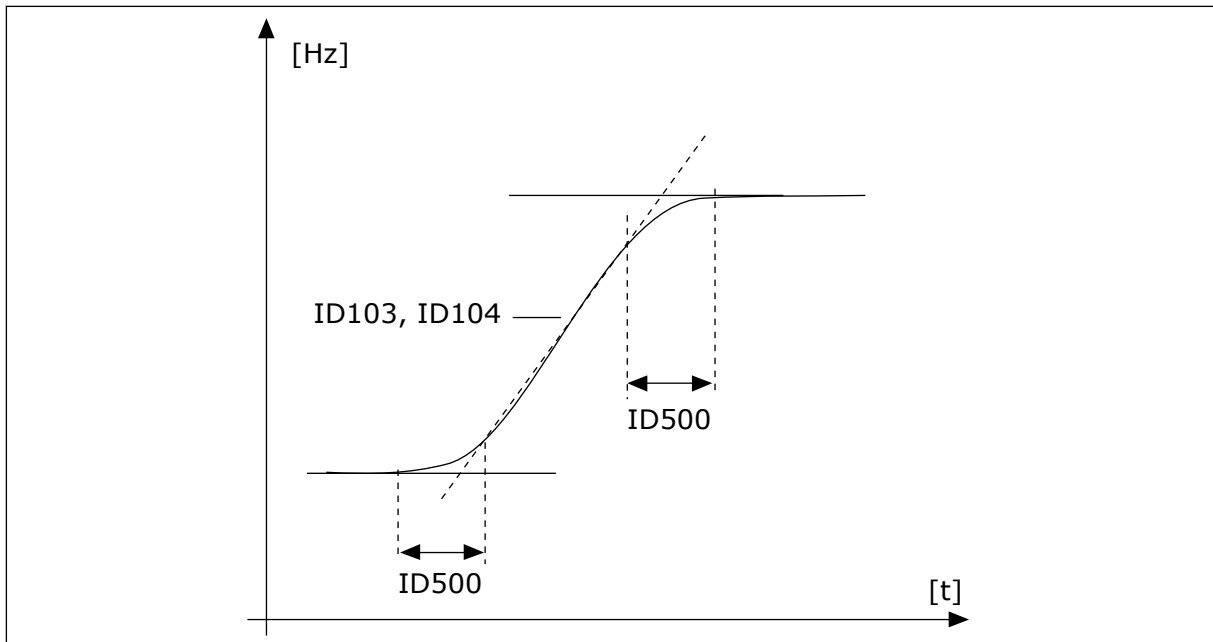

Fig. 19: The acceleration/deceleration curve (S-shaped)

P3.4.12 FLUX BRAKING (ID520)

As an alternative to DC braking, you can use flux braking. Flux braking increases the braking capacity in conditions where additional brake resistors are not necessary.

When braking is necessary, the system decreases the frequency and increases the flux in the motor. This increases the capacity of the motor to brake. The motor speed is controlled during braking.

You can enable and disable Flux Braking.



CAUTION!

Use the braking only intermittently. Flux braking converts energy into heat and can cause damage to the motor.

9.5 I/O CONFIGURATION

9.5.1 PROGRAMMING OF DIGITAL AND ANALOGUE INPUTS

The programming of inputs of the AC drive is flexible. You can freely use the available inputs of the standard and optional I/O for different functions.

Use the formats below to give the value for the programmable parameters:

- **DigIN SlotA.1 / AnIN SlotA.1** (graphical keypad) or
- **dl A.1 / al A.1** (text keypad).

Selection name	Example	Description
Input type	DigIN / dl	DigIN / dl = Digital input AnIN / al = Analogue input
Slot type	Slot A	The board type: A / B = Vacon AC drive standard board C / D / E = Option board 0 = The parameter signal is not connected to any terminal
Terminal number	1	The number of the terminal on the selected board.

For example, "DigIN SlotA.1" or "dl A.1" shows that the DIN1 on the standard board is connected in the board slot A.

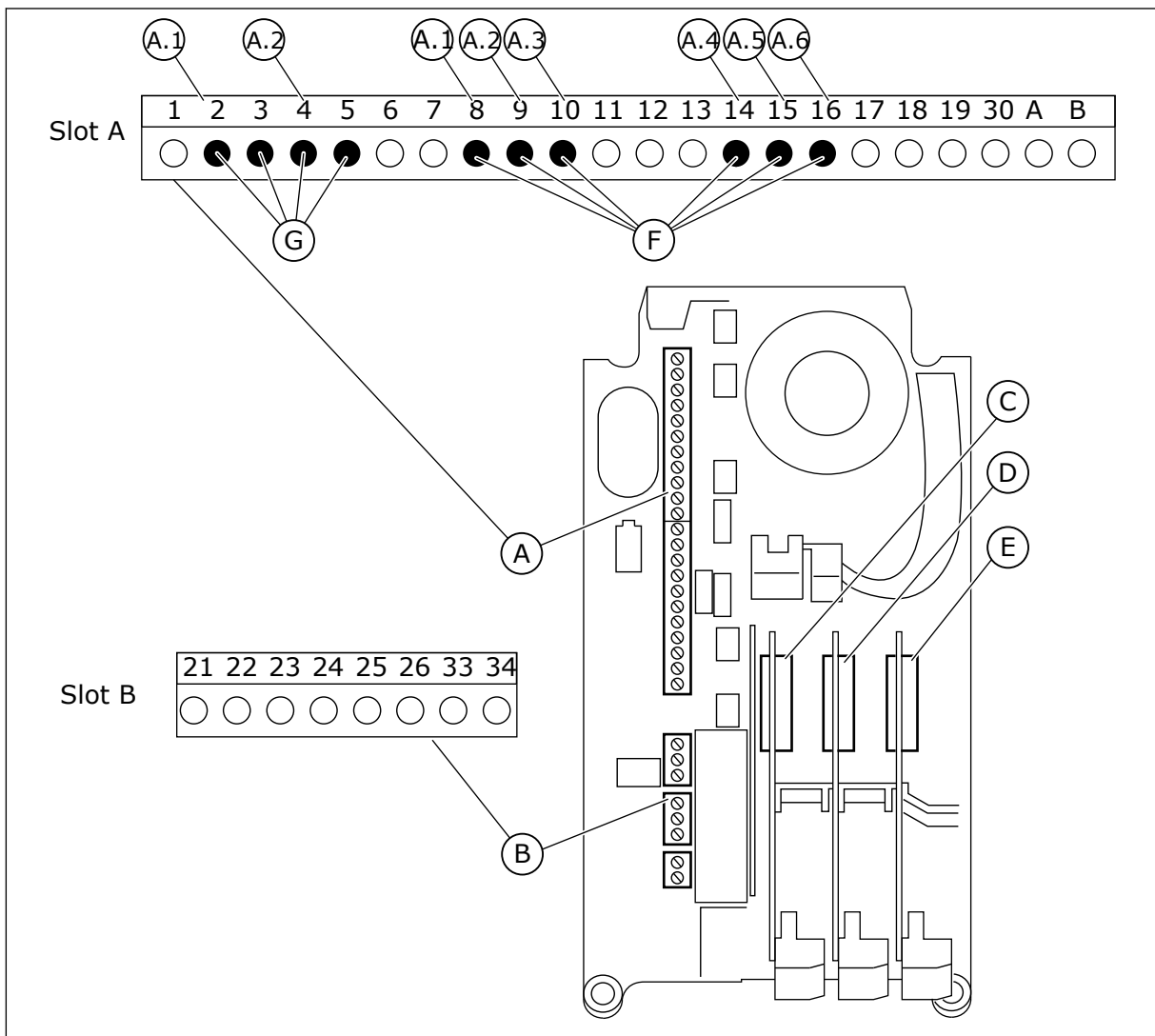

Fig. 20: The option board slots and programmable inputs

- A. Standard board slot A and its terminals
- B. Standard board slot B and its terminals

- C. Option board slot C
- D. Option board slot D
- E. Option board slot E
- F. Programmable digital inputs (DI)
- G. Programmable analogue inputs (AI)

9.5.1.1 Programming of digital inputs

You can find the applicable functions for digital inputs as parameters in parameter group M3.5.1. To give a digital input to a function, set a value to the correct parameter. The list of applicable functions shows in *Table 14 Digital input settings*.

Example

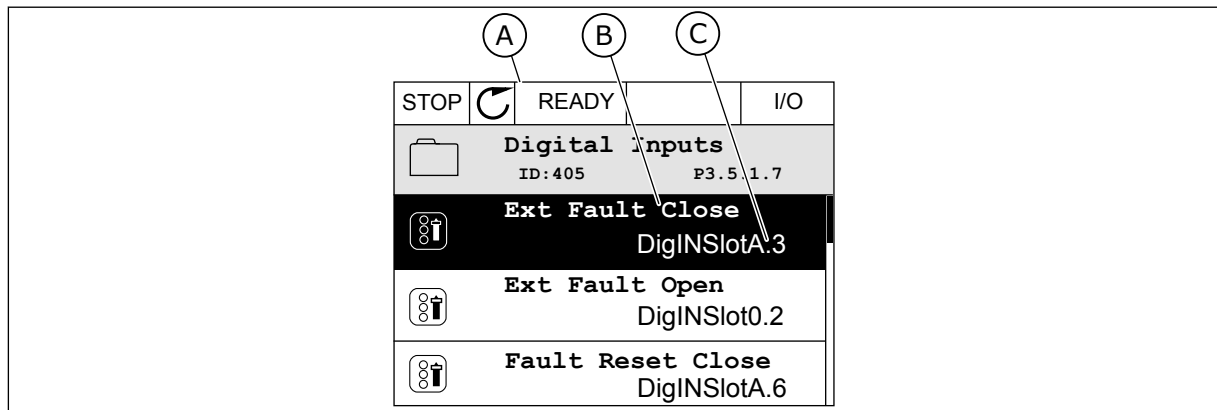

Fig. 21: The Digital inputs menu in the graphical display

- A. The graphical display
- B. The name of the parameter, that is, the function
- C. The value of the parameter, that is, the set digital input

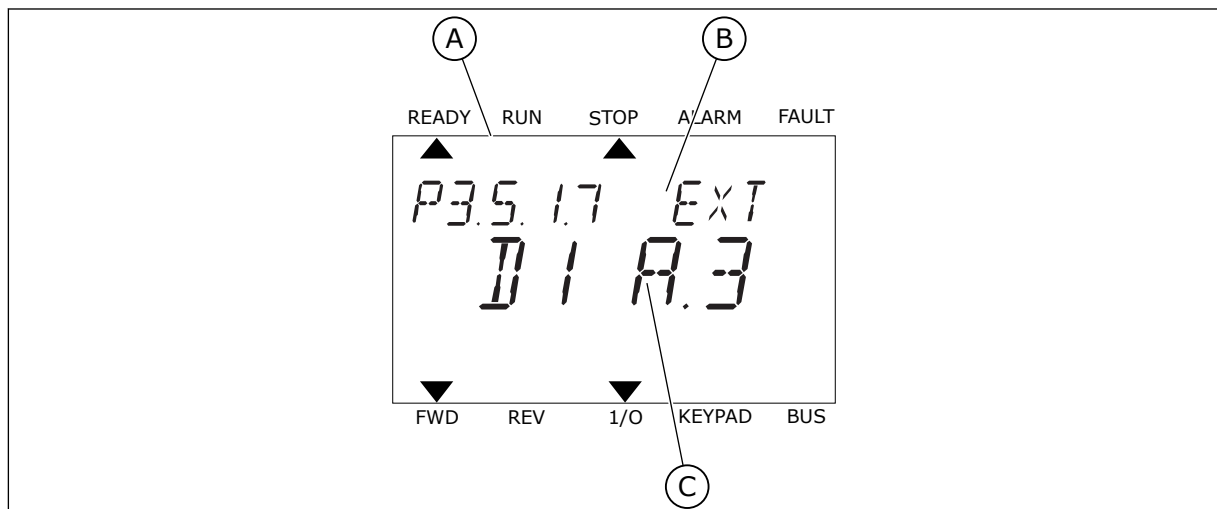

Fig. 22: The Digital inputs menu in the text display

- A. The text display
- B. The name of the parameter, that is, the function
- C. The value of the parameter, that is, the set digital input

In the standard I/O board compilation, there are 6 digital inputs available: the slot A terminals 8, 9, 10, 14, 15 and 16.

Input type (graphical display)	Input type (text display)	Slot	Input #	Explanation
DigIN	dl	A	1	Digital input #1 (terminal 8) on a board in Slot A (standard I/O board).
DigIN	dl	A	2	Digital input #2 (terminal 9) on a board in Slot A (standard I/O board).
DigIN	dl	A	3	Digital input #3 (terminal 10) on a board in Slot A (standard I/O board).
DigIN	dl	A	4	Digital input #4 (terminal 14) on a board in Slot A (standard I/O board).
DigIN	dl	A	5	Digital input #5 (terminal 15) on a board in Slot A (standard I/O board).
DigIN	dl	A	6	Digital input #6 (terminal 16) on a board in Slot A (standard I/O board).

The function External Fault Close, the location of which is the menu M3.5.1, is parameter P3.5.1.11. It gets the default value DigIN SlotA.3 in the graphical display, and dl A.3 in the text display. After this selection, a digital signal to the digital input DI3 (terminal 10) controls External Fault Close.

Index	Parameter	Default	ID	Description
P3.5.1.11	External fault close	DigIN SlotA.3	405	OPEN = OK CLOSED = External fault

To change the input from DI3 to, for example, DI6 (terminal 16) on the standard I/O, obey these instructions.

PROGRAMMING IN THE GRAPHICAL DISPLAY

- 1 Make a selection of a parameter. To go into the Edit mode, push the arrow button Right.

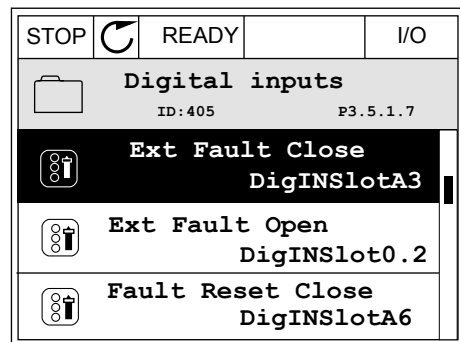

- In the Edit mode, the slot value DigIN SlotA is underlined and blinks. If you have more digital inputs available in your I/O, for example, because of option boards in slots C, D or E, make a selection of them.

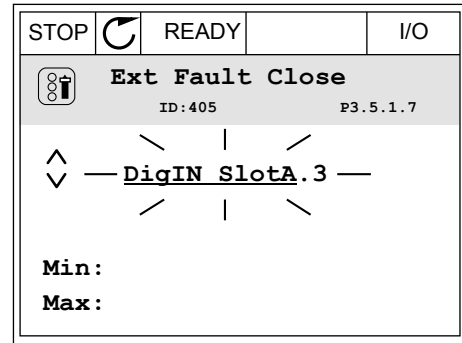

- To activate the terminal 3, push the arrow button Right again.

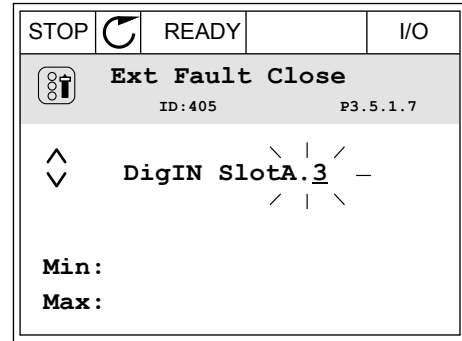

- To change the terminal to 6, push the arrow button Up 3 times. Accept the change with the OK button.

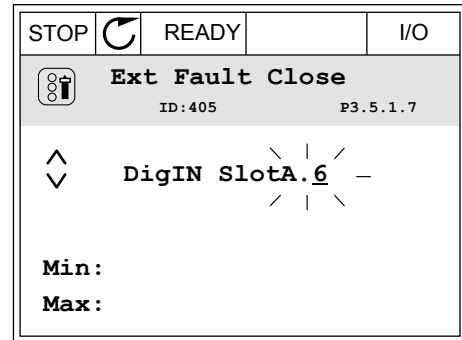

- If the digital input DI6 was already used for some other function, a message shows on the display. Change one of these selections.

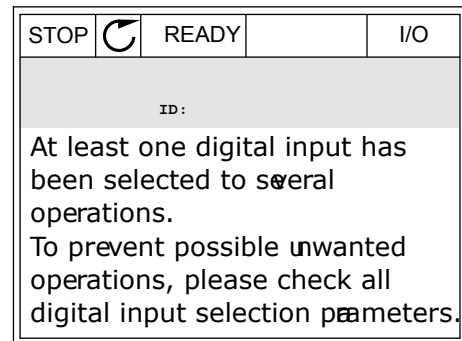

PROGRAMMING IN THE TEXT DISPLAY

- 1 Make a selection of a parameter. To go into the Edit mode, push the OK button.

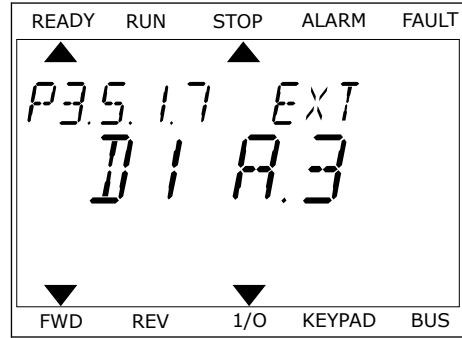

- 2 In the Edit mode, the letter D blinks. If you have more digital inputs available in your I/O, for example, because of option boards in slots D or E, make a selection of them.

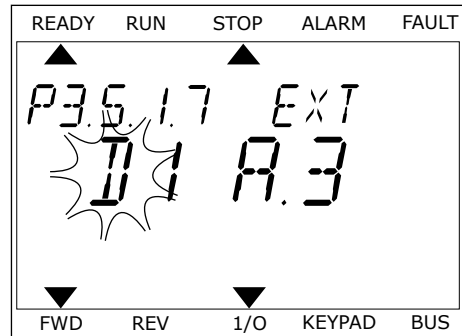

- 3 To activate the terminal 3, push the arrow button Right again. The letter D stops blinking.

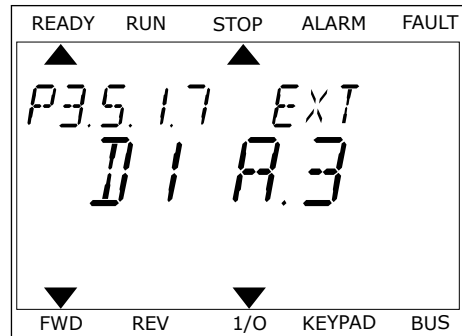

- 4 To change the terminal to 6, push the arrow button Up 3 times. Accept the change with the OK button.

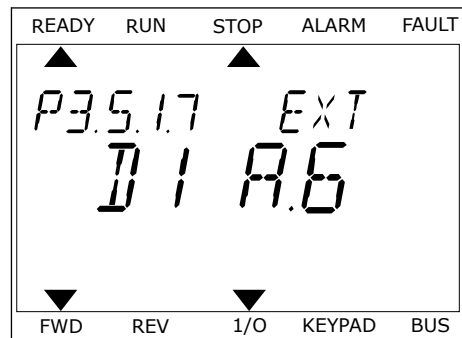

- 5 If the digital input DI6 was already used for some other function, a message scrolls on the display. Change one of these selections.

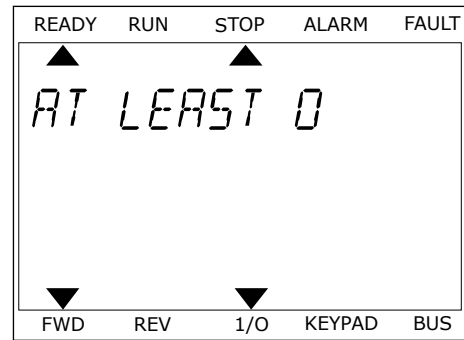

After the steps, a digital signal to the digital input DI6 controls the function External Fault Close.

The value of a function can be DigIN Slot0.1 (in the graphical display) or dl 0.1 (in the text display). In these conditions, you did not give a terminal to the function, or the the input was set to be always OPEN. This is the default value of most of parameters in the group M3.5.1. On the other hand, some inputs have the default value always CLOSED. Their value shows DigIN Slot0.2 in the graphical display and dl 0.2 in the text display.



NOTE!

You can also give time channels to digital inputs. There is more data about it in Table *Table 14 Digital input settings*.

9.5.1.2 Descriptions of signal sources

Source	Function
Slot0	1 = Always OPEN 2-9 = Always CLOSED
SlotA	Number agrees to a digital input in slot A.
SlotB	Number agrees to a digital input in slot B.
SlotC	Number agrees to a digital input in slot C.
SlotD	Number agrees to a digital input in slot D.
SlotE	Number agrees to a digital input in slot E.
TimeChannel (tCh)	1=Time Channel1, 2=Time Channel2, 3=Time Channel3

9.5.2 DIGITAL INPUTS

The parameters are functions that you can connect to a digital input terminal. The text *DigIn Slot A.2* means the second input on the slot A. It is also possible to connect the functions to time channels. The time channels work as terminals.

You can monitor the statuses of the digital inputs and the digital outputs in the Multimonitoring view.

P3.5.1.11 RUN ENABLE (ID 407)

When the contact is OPEN, the start of the motor is disabled.
When the contact is CLOSED, the start of the motor is enabled.

To stop, the drive obeys the value of P3.2.5 Stop Function. The follower drive will always coast to stop.

P3.5.1.12 RUN INTERLOCK 1 (ID 1041)**P3.5.1.13 RUN INTERLOCK 2 (ID 1042)**

If an interlock is active, the drive cannot start.

You can use this function to prevent the start of the drive when the damper is closed. If you activate an interlock during the operation of the drive, the drive stops.

P3.5.1.15 PRESET FREQUENCY SELECTION 0 (ID419)**P3.5.1.16 PRESET FREQUENCY SELECTION 1 (ID420)****P3.5.1.17 PRESET FREQUENCY SELECTION 2 (ID421)**

To apply Preset frequencies 1 to 7, connect a digital input to these functions with the instructions in Chapter 9.5.1 *Programming of digital and analogue inputs*. See more data in *Table 59 The selection of preset frequencies when P3.3.10 = Binary coded* and also in *Table 12 Control reference settings* and *Table 14 Digital input settings*.

9.5.3 ANALOGUE INPUTS**P3.5.2.2 AI1 SIGNAL FILTER TIME (ID 378)**

This parameter filters out disturbances in the analogue input signal. To activate this parameter, give it a value that is bigger than 0.

**NOTE!**

A long filter time makes the regulation response slow.

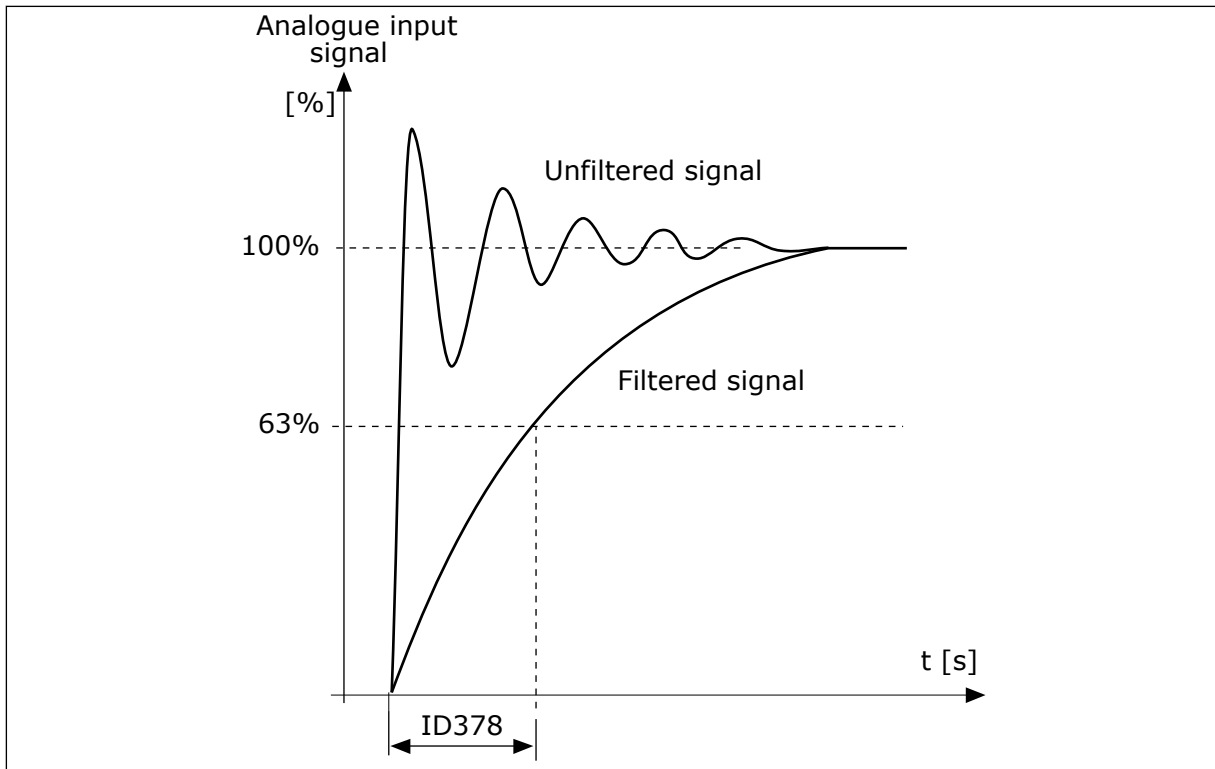

Fig. 23: The A11 signal filtering

9.5.4 DIGITAL OUTPUTS

P3.5.3.2.1 BASIC R01 FUNCTION (ID 11001)**Table 60: The output signals through R01**

Selection number	Selection name	Description
0	Not used	The output is not used.
1	Ready	The AC drive is ready to operate.
2	Run	The AC drive operates (the motor runs).
3	General fault	A fault trip occurred.
4	General fault inverted	A fault trip did not occur.
5	General alarm	
6	Reversed	The reverse command is given.
7	At speed	The output frequency has become the same as the set frequency reference.
8	Motor regulator activated	One of the limit regulators (for example current limit or torque limit) is activated.
9	Preset Frequency active	The selection of preset frequency was made with digital input signals.
10	Keypad control active	The selection is keypad control (the active control place is keypad).
11	I/O control B active	The selection is I/O control place B (the active control place is I/O B).
12	Limit supervision 1	The limit supervision activates if the signal value goes below or above the set supervision limit (P3.8.3 or P3.8.7).
13	Limit supervision 2	
14	Start command active	Start command is active.
15	Reserved	
16	Fire mode ON	
17	RTC timer 1 control	Time channel 1 is in use.
18	RTC timer 2 control	Time channel 2 is in use.
19	RTC timer 3 control	Time channel 3 is in use.
20	FB Control WordB 13	
21	FB Control WordB 14	

Table 60: The output signals through R01

Selection number	Selection name	Description
22	FB Control WordB 15	
23	PID in Sleep mode	
24	Reserved	
25	PID1 supervision limits	The feedback value of the PID1 controller is not in the supervision limits.
26	PID2 supervision limits	The feedback value of the PID2 controller is not in the supervision limits.
27	Motor 1 control	The contactor control for the Multi-pump function.
28	Motor 2 control	The contactor control for the Multi-pump function.
29	Motor 3 control	The contactor control for the Multi-pump function.
30	Motor 4 control	The contactor control for the Multi-pump function.
31	Motor 5 control	The contactor control for the Multi-pump function.
32	Reserved	(Always open)
33	Reserved	(Always open)
34	Maintenance warning	
35	Maintenance fault	
36	Thermistor Fault	A thermistor fault occurred.
37	Motor Switch	The Motor Switch function has detected that the switch between the drive and the motor is open.
38	PreHeat	
39	kWh Pulse Output	
40	Run Indication	
41	Selected Param.Set	

9.6 PROHIBIT FREQUENCIES

In some processes it can be necessary to avoid some frequencies because they make problems of mechanical resonance. With the Prohibit frequencies function, it is possible to prevent the usage of these frequencies. When the input frequency reference increases, the internal frequency reference stays at the low limit, until the input frequency reference is above the high limit.

9.7 PROTECTIONS

P3.9.2 RESPONSE TO EXTERNAL FAULT (ID701)

With this parameter, you can set the response of the drive to an external fault. If a fault occurs, the drive can show a notification of it on the display of the drive. The notification is made with a digital input. The default digital input is DI3. You can also program the response data into a relay output.

9.7.1 MOTOR THERMAL PROTECTIONS

The motor thermal protection prevents the motor from becoming too hot.

The AC drive can supply a current that is higher than the nominal current. The high current can be necessary to the load, and it must be used. In these conditions, there is a risk of a thermal overload. Low frequencies have a higher risk. At low frequencies, the cooling effect and the capacity of the motor decrease. If the motor has an external fan, the load reduction at low frequencies is small.

The motor thermal protection is based on calculations. The protection function uses the output current of the drive to know what is the load on the motor. If the control board is not energised, the calculations are reset.

To adjust the thermal protection of the motor, use the parameters from P3.9.6 to P3.9.10. The thermal current I_T tells the load current above which the motor is overloaded. This current limit is a function of the output frequency.



NOTE!

If you use long motor cables (max. 100 m) with small drives (≤ 1.5 kW), the motor current that the drive measures can be much higher than the actual motor current. It is because there are capacitive currents in the motor cable.



CAUTION!

Make sure that the airflow to the motor is not blocked. If the airflow is blocked, the function does not protect the motor, and the motor can become too hot. This can cause damage to the motor.

P3.9.8 MOTOR THERMAL ZERO SPEED COOLING (ID706)

When the speed is 0, this function calculates the cooling factor in relation to the point where the motor operates at a nominal speed without external cooling.

The default value is set for conditions where there is no external fan. If you use an external fan, you can set the value higher than without the fan, for example at 90%.

If you change parameter P3.1.1.4 (Motor Nominal Current), parameter P3.9.2.3 is automatically set to its default value.

Although you change this parameter, it does not have an effect on the maximum output current of the drive. Only parameter P3.1.1.7 Motor Current Limit can change the maximum output current.

The corner frequency for the thermal protection is 70% of the value of the parameter P3.1.1.2 Motor Nominal Frequency.

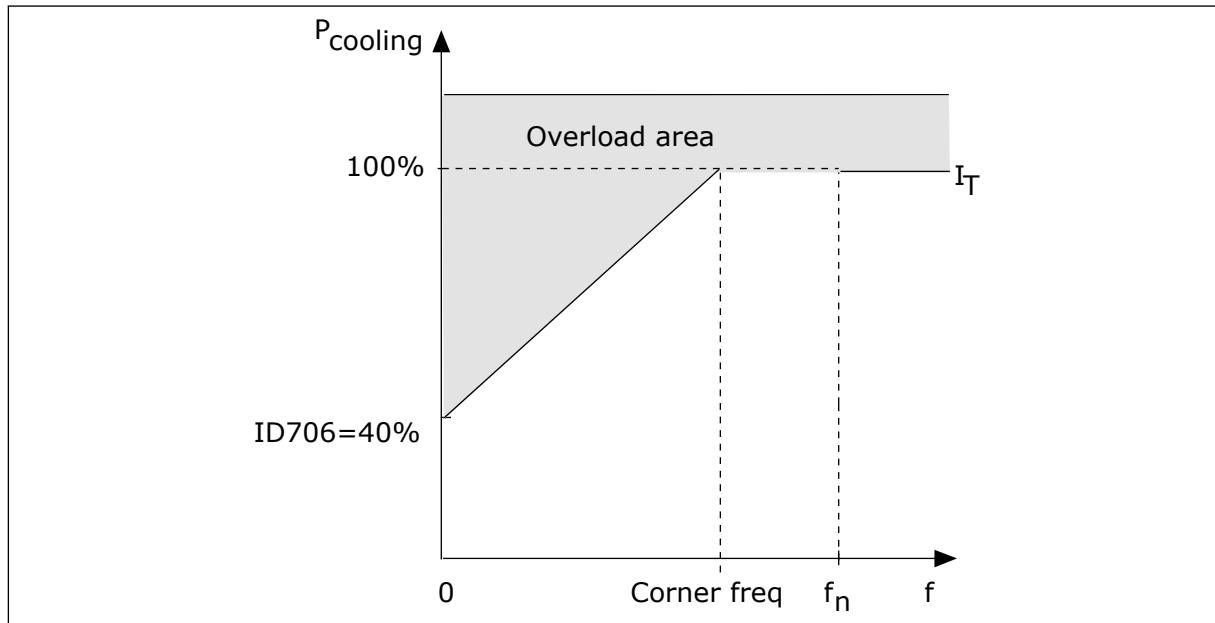

Fig. 24: The motor thermal current I_T curve

P3.9.9 MOTOR THERMAL TIME CONSTANT (ID707)

The time constant is the time during which the calculated warming curve becomes 63% of its target value. The length of the time constant is in relation with the dimension of the motor. The bigger the motor, the longer the time constant.

In different motors, the motor thermal time constant is different. It also changes between different motor manufacturers. The default value of the parameter changes from dimension to dimension.

The t_6 -time is the time in seconds that the motor can safely operate at 6 times the rated current. It is possible that the motor manufacturer gives the data with the motor. If you know the t_6 of the motor, you can set the time constant parameter with its help. Usually, the motor thermal time constant in minutes is $2 \cdot t_6$. When the drive is in the STOP state, the time constant is internally increased to 3 times the set parameter value, because the cooling operates based on convection. See Fig. 25 The calculation of the motor temperature.

P3.9.10 MOTOR THERMAL LOADABILITY (ID708)

For example, if you set the value to 130%, the motor goes to the nominal temperature with 130% of the motor nominal current.

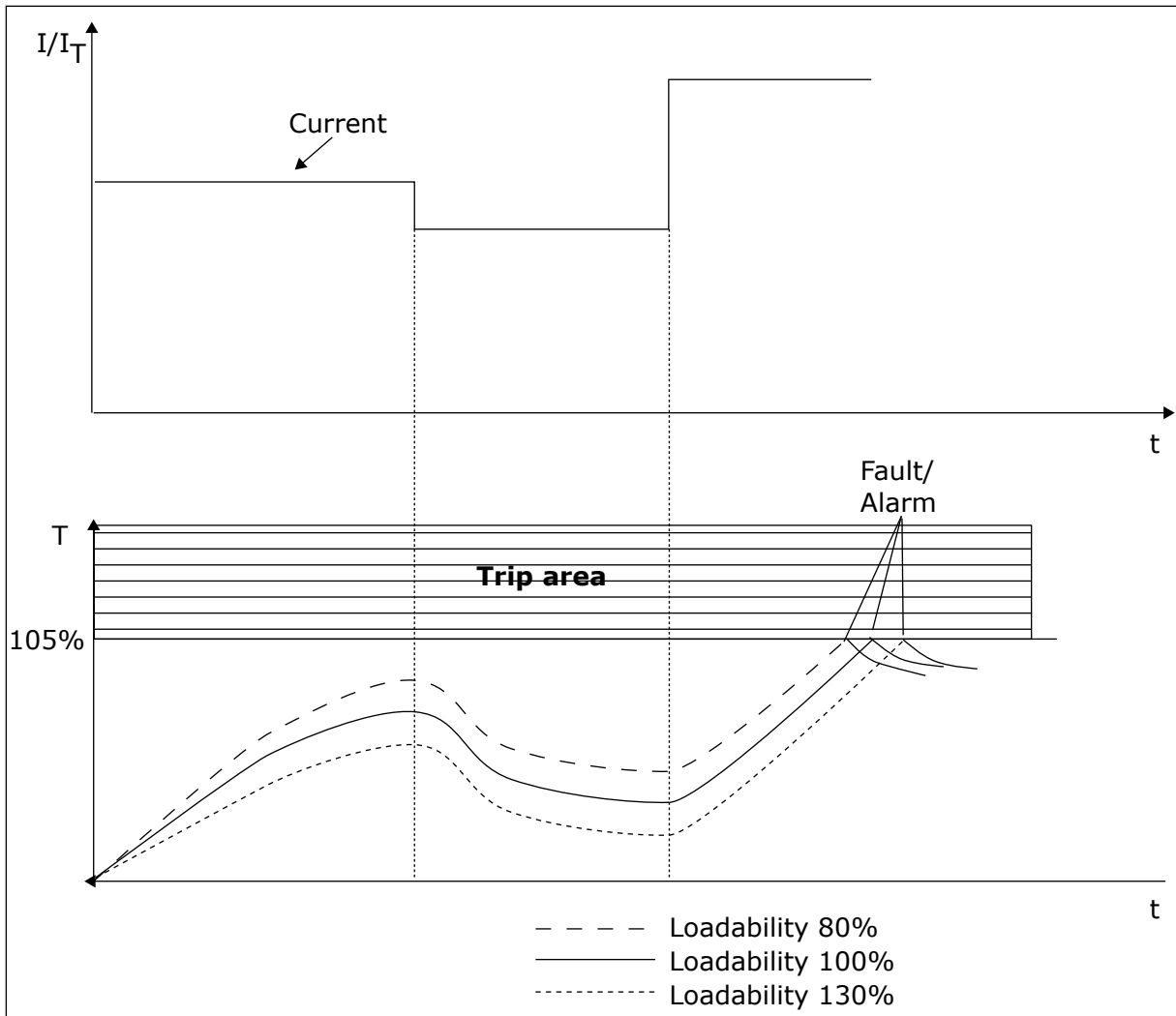

Fig. 25: The calculation of the motor temperature

9.7.2 MOTOR STALL PROTECTION

The motor stall protection function gives protection to the motor against short overloads. An overload can be caused, for example, by a stalled shaft. It is possible to set the reaction time of the stall protection shorter than that of the motor thermal protection.

The stall status of the motor is specified with parameters P3.9.12 Stall Current and P3.9.14 Stall Frequency Limit. If the current is higher than the limit, and the output frequency is lower than the limit, the motor is in a stall status.

The stall protection is a type of overcurrent protection.



NOTE!

If you use long motor cables (max. 100 m) with small drives (≤ 1.5 kW), the motor current that the drive measures can be much higher than the actual motor current. It is because there are capacitive currents in the motor cable.

P3.9.12 STALL CURRENT (ID710)

You can set the value of this parameter between 0.0 and $2 \cdot I_L$. For a stall status to occur, the current must be higher than this limit. If parameter P3.1.1.7 Motor Current Limit changes, this parameter is automatically calculated to 90% of the current limit.



NOTE!

The value of the Stall Current must be below the motor current limit.

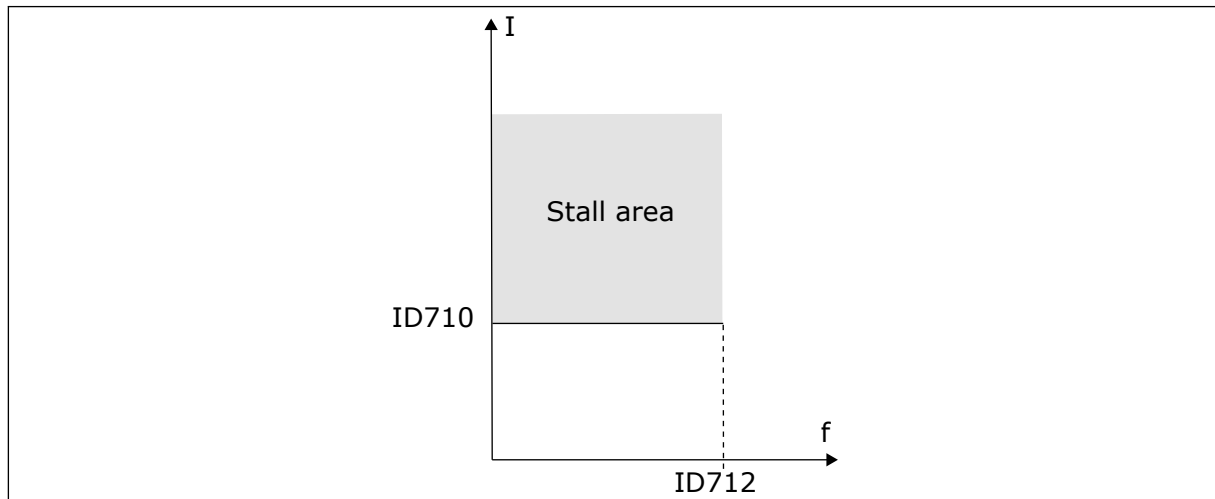

Fig. 26: The stall characteristics settings

P3.9.13 STALL TIME LIMIT (ID711)

You can set the value of this parameter between 1.0 and 120.0 s. This is the maximum time for the stall status to be active. An internal counter counts the stall time.

If the stall time counter value goes above this limit, the protection causes the drive to trip.

9.7.3 UNDERLOAD (DRY PUMP) PROTECTION

The motor underload protection makes sure that there is a load on the motor when the drive operates. If the motor loses the load, a problem can occur in the process. For example, a belt can break or a pump become dry.

You can adjust the motor underload protection with parameters P3.9.16 (Underload Protection: Field Weakening Area Load) and P3.9.17 (Underload Protection: Zero Frequency Load). The underload curve is a squared curve between the zero frequency and the field weakening point. The protection is not active below 5 Hz. The underload time counter does not operate below 5 Hz.

The values of the underload protection parameters are set in percentage of the nominal torque of the motor. To find the scaling ratio for the internal torque value, use the data in the name plate data of the motor, the motor nominal current and the nominal current of the drive I_L . If you use another current than the nominal motor current, the precision of the calculation decreases.

**NOTE!**

If you use long motor cables (max. 100 m) with small drives (≤ 1.5 kW), the motor current that the drive measures can be much higher than the actual motor current. It is because there are capacitive currents in the motor cable.

P3.9.16 UNDERLOAD PROTECTION: FIELD WEAKENING AREA LOAD (ID714)

You can set the value of this parameter between 10.0 and 150.0% $\times T_{nMotor}$. This value is the limit for the minimum torque when the output frequency is above the field weakening point.

If you change parameter P3.1.1.4 (Motor Nominal Current), this parameter goes automatically back to its default value. See Chapter 5.9 Group 3.9: *Protections*.

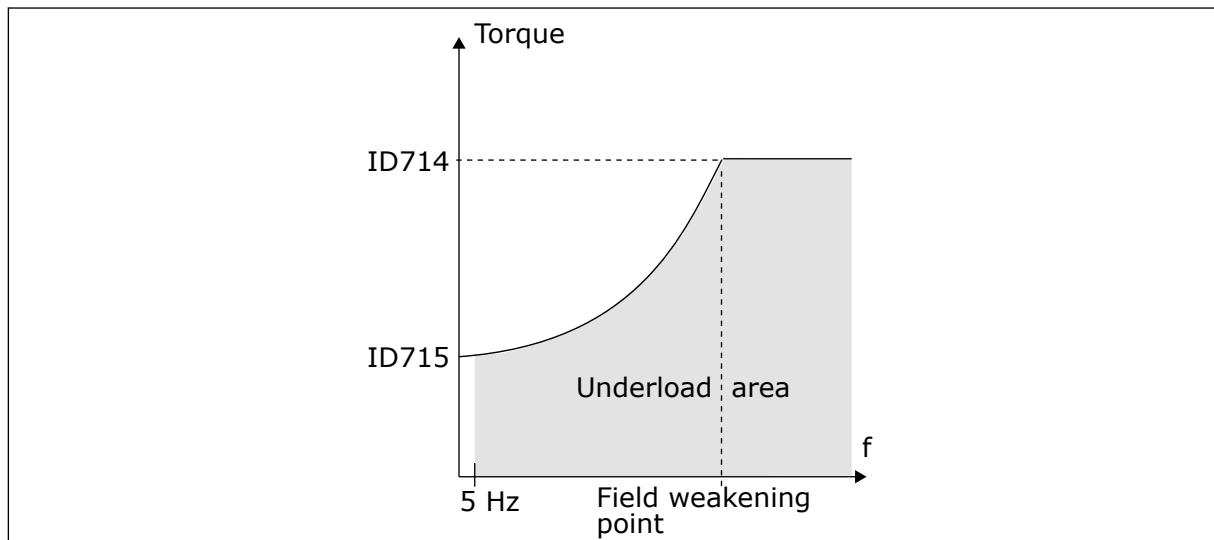

Fig. 27: Setting of the minimum load

P3.9.18 UNDERLOAD PROTECTION: TIME LIMIT (ID716)

You can set the time limit between 2.0 and 600.0 s.

This is the maximum time for an underload status to be active. An internal counter counts the underload time. If the value of the counter goes above this limit, the protection causes the drive to trip. The drive trips as is set in parameter P3.9.15 Underload Fault. If the drive stops, the underload counter goes back to 0.

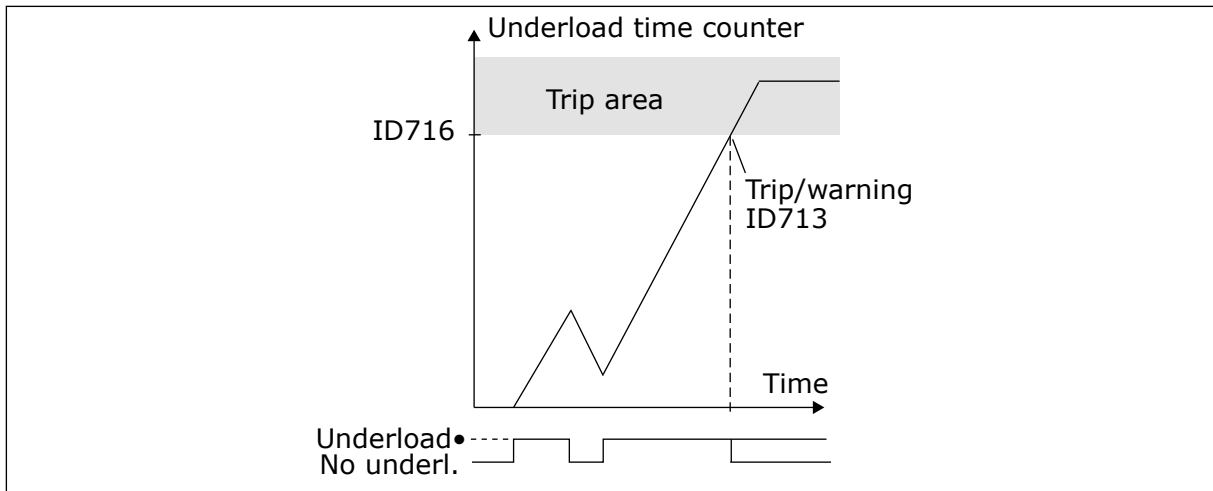

Fig. 28: The Underload time counter function

P3.9.29 RESPONSE TO SAFE TORQUE OFF (STO) FAULT (ID 775)

This parameter defines the response for F30 – Safe Torque Off (Fault ID: 530).

This parameter defines drive operation when Safe Torque Off (STO) function is activated (e.g. emergency stop button has been pressed or some other STO operation has been activated).

0 = No action

1 = Alarm

2 = Fault, stop by coasting



NOTE!

This parameter is not visible if the drive does not have support for safety torque off functionality.

9.8 AUTOMATIC RESET

P3.10.1 AUTOMATIC RESET

Use parameter P3.10.1 to enable the Automatic reset function. To make a selection of faults that are reset automatically, give the value 0 or 1 to parameters from P3.10.6 to P3.10.14.



NOTE!

The automatic reset function is available only for some fault types.

P3.10.3 WAIT TIME (ID 717)

Use this parameter to set the wait time before the first reset is done.

P3.10.4 AUTOMATIC RESET: TRIAL TIME (ID 718)

Use this parameter to set the trial time for the automatic reset function. During the trial time, the automatic reset function tries to reset the faults that occur. The time count starts from the first automatic reset. The next fault starts the trial time count again.

P3.10.5 NUMBER OF TRIALS (ID 759)

If the number of trials during the trial time is more than the value of this parameter, a permanent fault shows. If not, the fault goes out of view after the trial time is completed.

With parameter P3.10.5, you can set the maximum number of automatic reset trials during the trial time set in P3.10.4. The fault type does not have an effect on the maximum number.

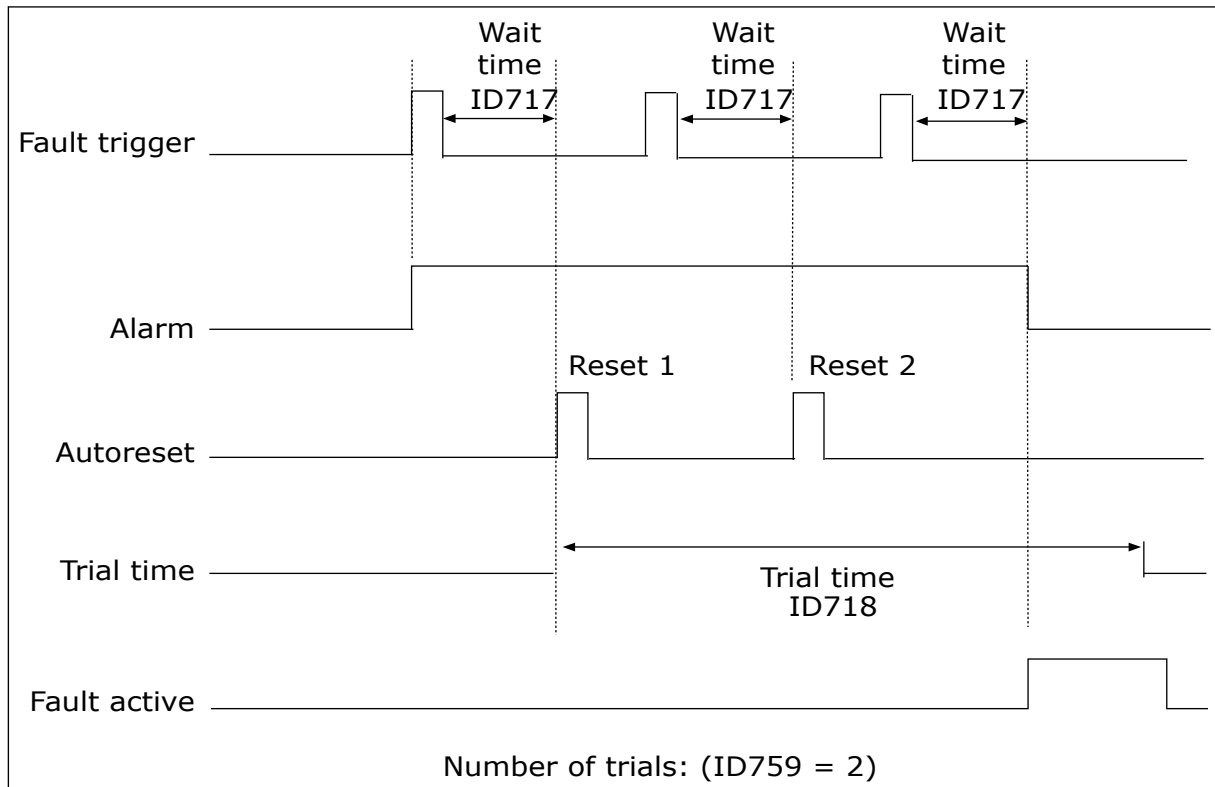

Fig. 29: The Automatic reset function

9.9 TIMER FUNCTIONS

The timer functions make it possible for the internal RTC (Real Time Clock) to control functions. All the functions that can be controlled with a digital input, can also be controlled with the RTC, with time channels 1-3. It is not necessary to have an external PLC to control a digital input. You can program the closed and opened intervals of the input internally.

To get the best results of the timer functions, install a battery, and make the settings of the Real Time Clock carefully in the Start-up wizard. The battery is available as an option.

**NOTE!**

We do not recommend that you use the timer functions without an auxiliary battery. The time and date settings of the drive are reset at each power down, if there is no battery for the RTC.

TIME CHANNELS

You can assign the output of the interval and/or timer functions to time channels 1-3. You can use the time channels to control on/off type functions, for example relay outputs or digital inputs. To configure the on/off logic of the time channels, assign intervals and/or timers to them. A time channel can be controlled by many different intervals or timers.

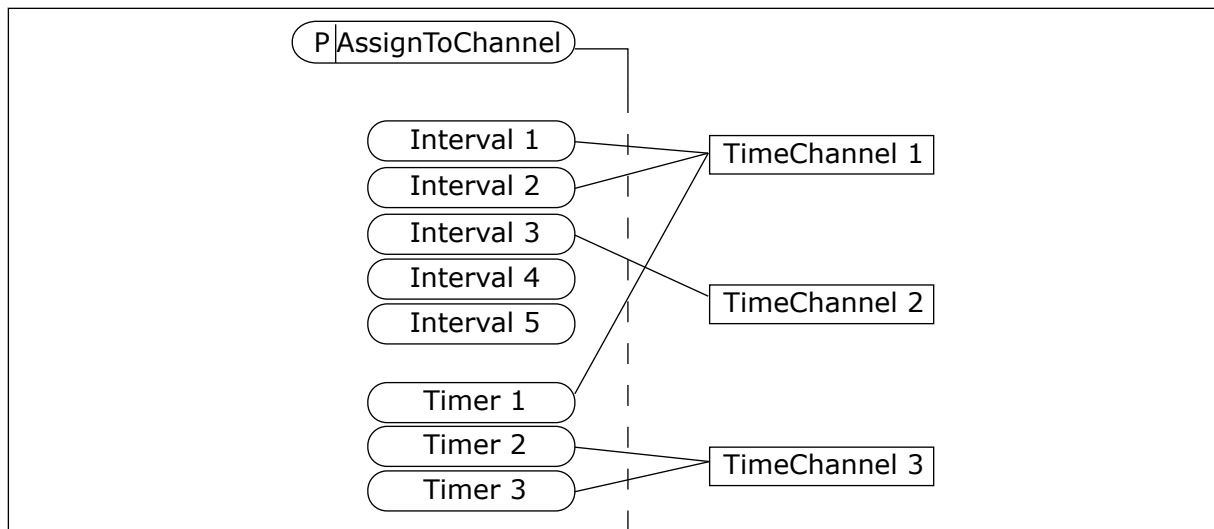

Fig. 30: Assigning intervals and timers to time channels is flexible. Every interval and timer has a parameter with which you can assign them to a time channel.

INTERVALS

Use parameters to give each interval an ON Time and OFF Time. It is the daily active time of the interval during the days set with parameters From Day and To Day. For example, with the parameter settings below, the interval is active from 7 am to 9 am from Monday to Friday. The time channel is like a digital input, but virtual.

ON Time: 07:00:00
 OFF Time: 09:00:00
 From Day: Monday
 To Day: Friday

TIMERS

Use the timers to set a time channel as active for a period with a command from a digital input or a time channel.

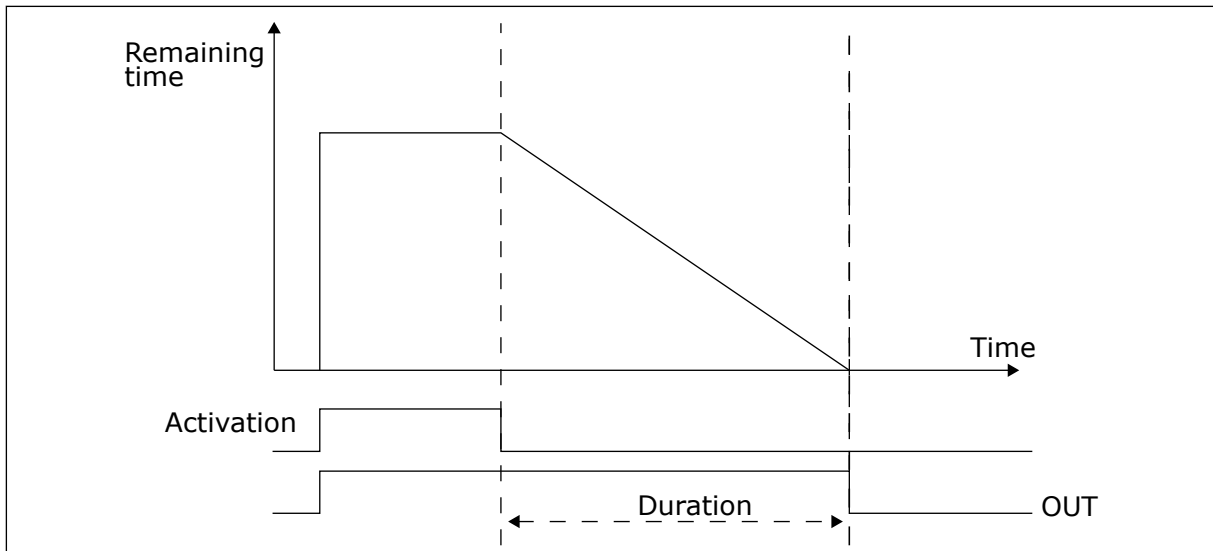

Fig. 31: The activation signal comes from a digital input or a virtual digital input, like a time channel. The timer counts down from the falling edge.

The parameters below will set the timer active when the digital input 1 on the slot A is closed. They will also keep the timer active for 30 s after it is opened.

- Duration: 30 s
- Timer: DigIn SlotA.1

You can use a duration of 0 seconds to override a time channel that is activated from a digital input. There is no off delay after the falling edge.

Example:

Problem:

The AC drive is in a warehouse and controls air conditioning. It must operate between 7 am and 5 pm on weekdays and between 9 am and 1 pm on weekends. It is also necessary for the drive to operate outside these hours, if there are personnel in the building. The drive must continue to operate 30 minutes after the personnel has left.

Solution:

Set 2 intervals, 1 for weekdays and 1 for weekends. A timer is also necessary to activate the process outside the set hours. See the configuration below.

Interval 1

- P3.11.1.1: ON Time: 07:00:00
- P3.11.1.2: OFF Time: 17:00:00
- P3.11.1.3: From Day: 1 (= Monday)
- P3.11.1.4: To Day: 5 (= Friday)
- P3.11.1.5: Assign to channel: Time channel 1

Interval 2

P3.11.2.1: ON Time: 09:00:00

P3.11.2.2: OFF Time: 13:00:00

P3.11.2.3: From Day: Saturday

P3.11.2.4: To Day: Sunday

P3.11.2.5: Assign to channel: Time channel 1

Timer 1

You can start the motor with the digital input 1 on slot A during other times than those specified with the intervals. In this case, the timer specifies the duration that the motor runs.

P3.11.6.1: Duration: 1800 s (30 min)

P3.11.6.2: Assign to channel: Time channel 1

P3.5.1.18: Timer 1: DigIn SlotA.1 (The parameter located in the digital inputs menu)

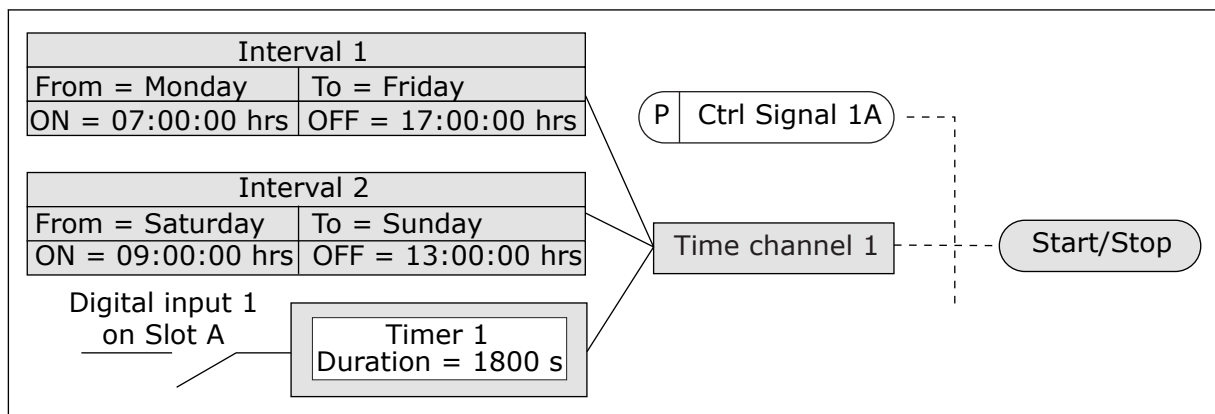

Fig. 32: Time channel 1 is used as the control signal for the start command instead of a digital input

9.10 PID CONTROLLER 1

P3.13.1.9 DEAD BAND HYSTERESIS (ID 1056)

9.10.1 SETPOINTS

P3.12.2.8 SLEEP DELAY 1 (ID1017)

See the description of parameter P3.12.2.10.

P3.12.2.9 WAKE-UP LEVEL 1 (ID1018)

See the description of parameter P3.12.2.10.

P3.12.2.10 SP1 WAKE-UP MODE (ID 15539)

With these parameters, you can set when the drive wakes up from the sleep mode.

The drive wakes up from the sleep mode when the value of PID Feedback goes below the Wake-up level.

This parameter defines if Wake-up level is used as a static absolute level or as a relative level which follows PID setpoint value.

Selection 0 = Absolute level (The wake-up level is a static level that does not follow the setpoint value.)

Selection 1 = Relative setpoint (The wake-up level is an offset below the actual setpoint value. The wake-up level follows the actual setpoint.)

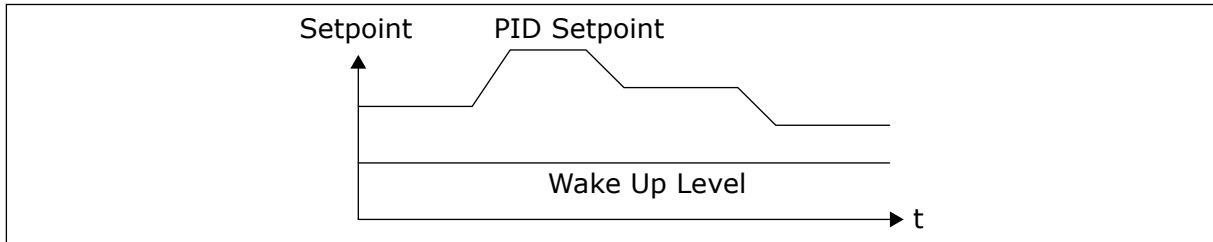

Fig. 33: Wake-up Mode: absolute level

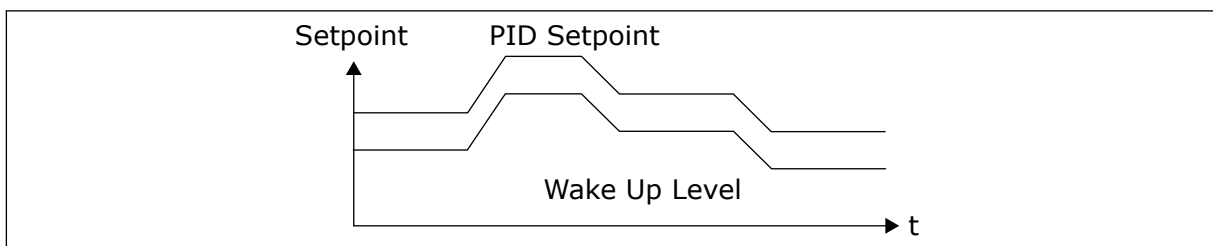

Fig. 34: Wake-up Mode: relative setpoint

P3.12.2.7 SLEEP FREQUENCY LIMIT 1 (ID1016)

See the description of parameter P3.12.2.10.

9.10.2 FEEDFORWARD

P3.12.4.1 FEEDFORWARD FUNCTION (ID 1059)

Accurate process models are usually necessary for the Feedforward function. In some conditions, a gain and offset type of feedforward is sufficient. The feedforward part does not use the feedback measurements of the actual controlled process value. The feedforward control uses other measurements that have an effect on the controlled process value.

EXAMPLE 1:

You can control the water level of a tank with flow control. The target water level is set as a setpoint, and the actual level as feedback. The control signal monitors the flow that comes in.

The outflow is like a disturbance that you can measure. With the measurements of the disturbance, you can try to adjust this disturbance with a feedforward control (gain and offset) that you add to the PID output. The PID controller reacts much faster to changes in the outflow than if you only measure the level.

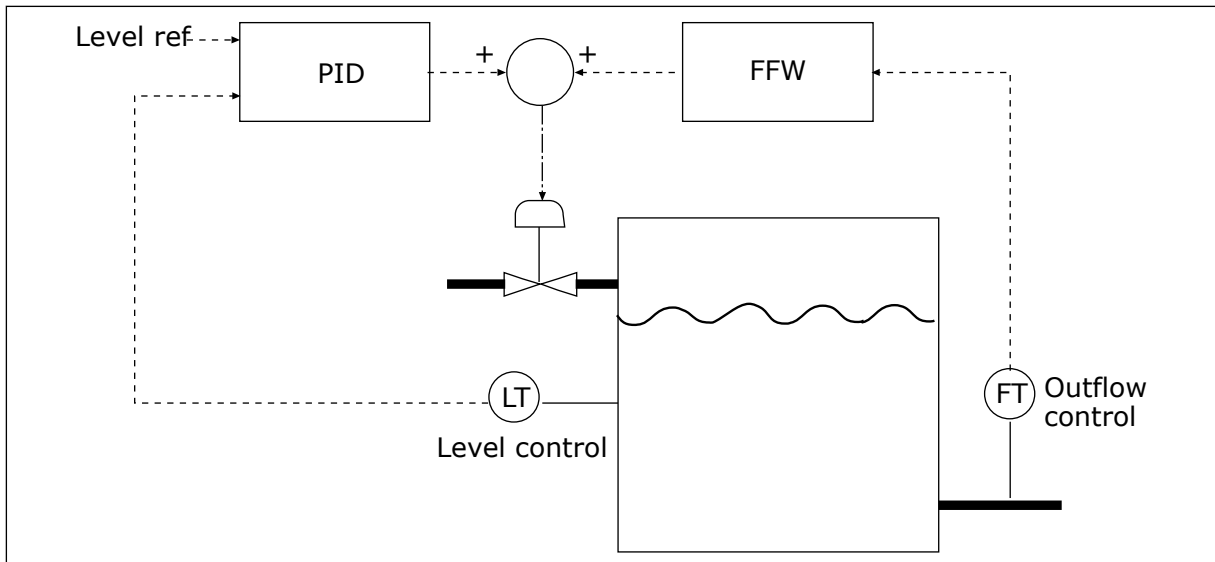

Fig. 35: The feedforward control

9.10.3 PROCESS SUPERVISION

Use the process supervision to make sure that the PID Feedback value (the process value or the actual value) stays in the set limits. With this function you can, for example, find a pipe break and stop the flooding.

P3.12.5.1 ENABLE PROCESS SUPERVISION (ID 735)

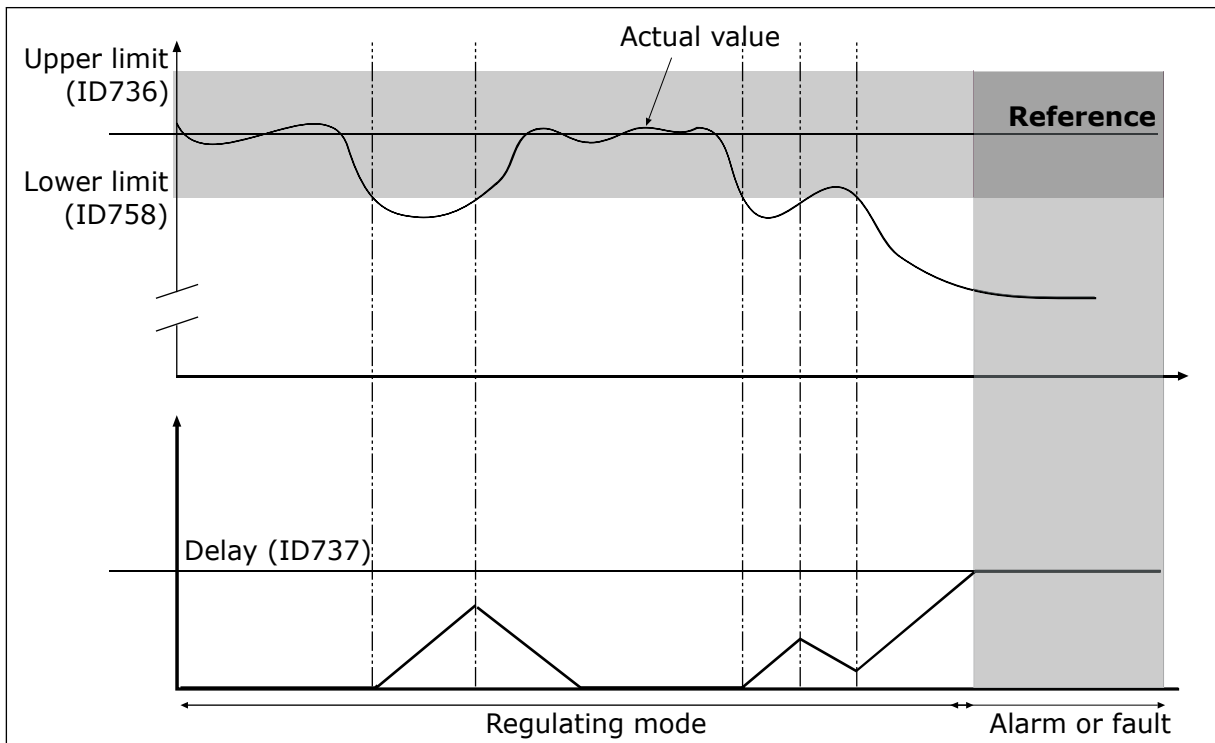

Fig. 36: The Feedback supervision function

Set the upper limit and the lower limit around the reference. When the actual value is less or more than the limits, a counter starts to count up. When the actual value is between the

limits, the counter counts down. When the counter gets a value that is higher than the value of P3.12.5.4 Delay, an alarm or a fault shows.

9.10.4 PRESSURE LOSS COMPENSATION

When you pressurise a long pipe that has many outlets, the best position for the sensor is in the middle of the pipe (the position 2 in the figure). You can also put the sensor directly after the pump. This gives the right pressure directly after the pump, but farther in the pipe, the pressure drops with the flow.

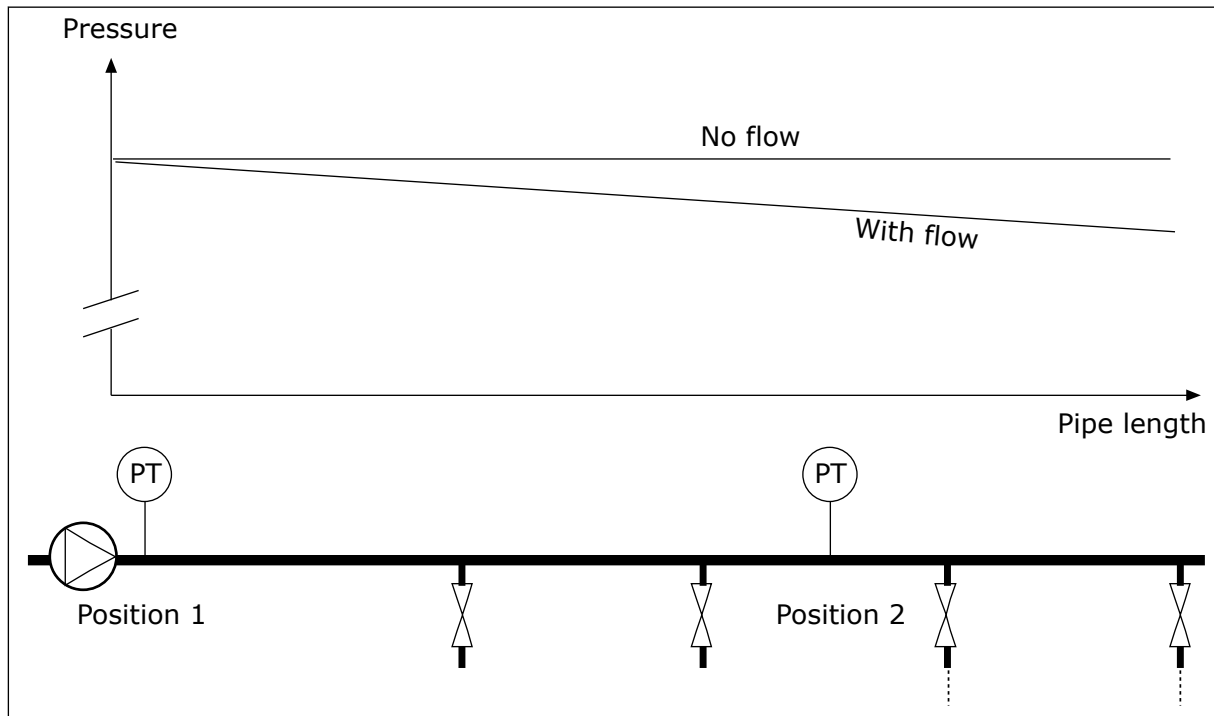

Fig. 37: The position of the pressure sensor

P3.12.6.1 ENABLE SETPOINT 1 (ID1189)

P3.11.6.2 SETPOINT 1 MAX COMPENSATION (ID 1190)

The sensor is put in position 1. The pressure in the pipe stays constant when there is no flow. But with flow, the pressure decreases farther in the pipe. To compensate for this, lift the setpoint as the flow increases. Then the output frequency makes an estimate of the flow, and the setpoint increases linearly with the flow.

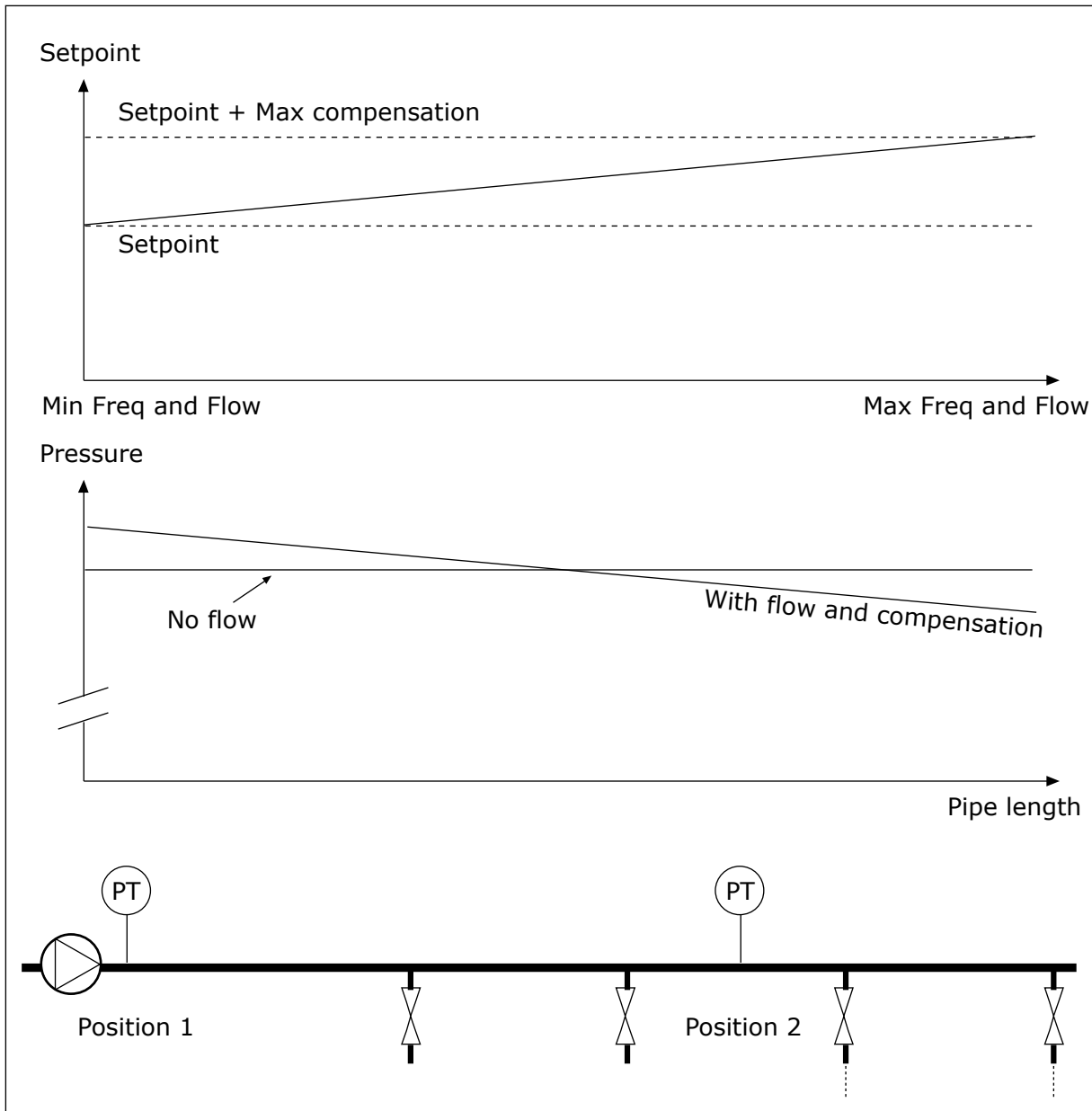

Fig. 38: Enable setpoint 1 for pressure loss compensation

9.11 PID CONTROLLER 2

P3.13.1.10 DEAD BAND DELAY (ID 1057)

If the actual value stays in the dead band area for a time set in Dead Band Delay, the PID controller output is locked. This function prevents wear and unwanted movements of the actuators, for example valves.

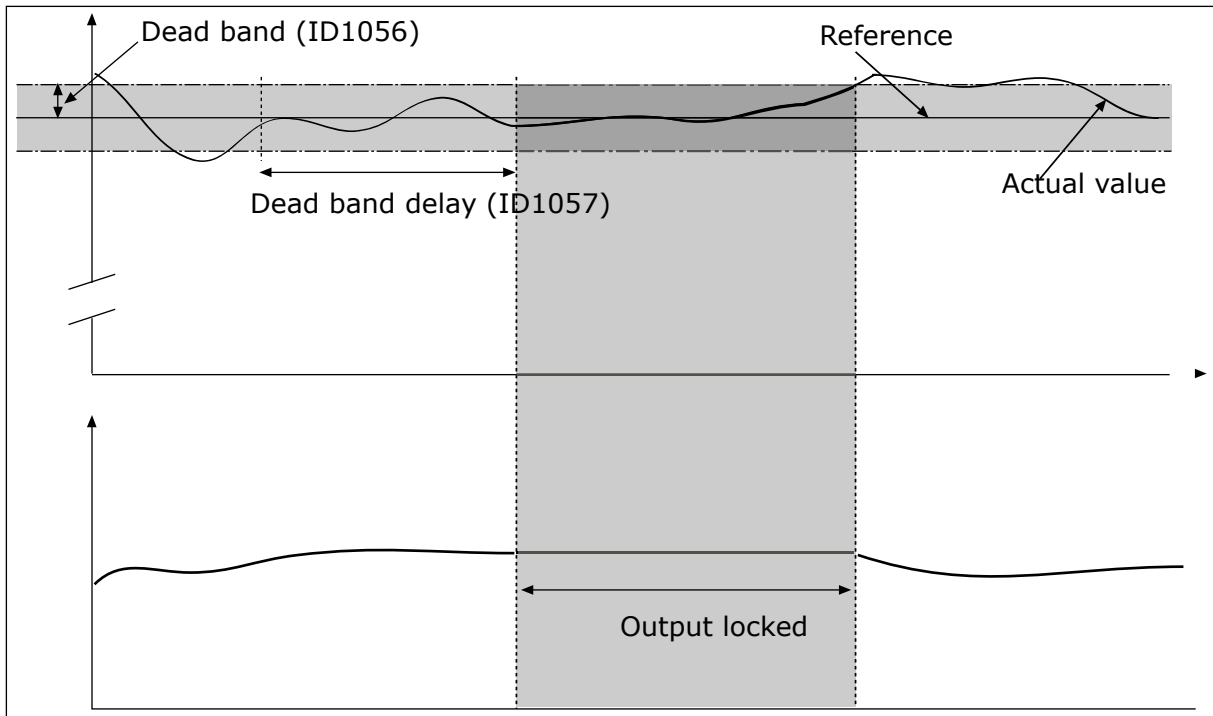

Fig. 39: The Dead band function

9.12 MULTIPUMP FUNCTION

The Multi-pump function lets you control a maximum of 4 motors, pumps or fans with the PID controller.

The AC drive is connected to a motor, which is the regulating motor. The regulating motor connects and disconnects the other motors to/from the mains with relays. This is done to keep the right setpoint. The Autochange function controls the sequence in which the motors start to make sure that they wear equally. You can include the regulating motor in the autochange and interlock logic, or set it to always be Motor 1. It is possible to remove motors momentarily with the Interlock function, for example for maintenance.

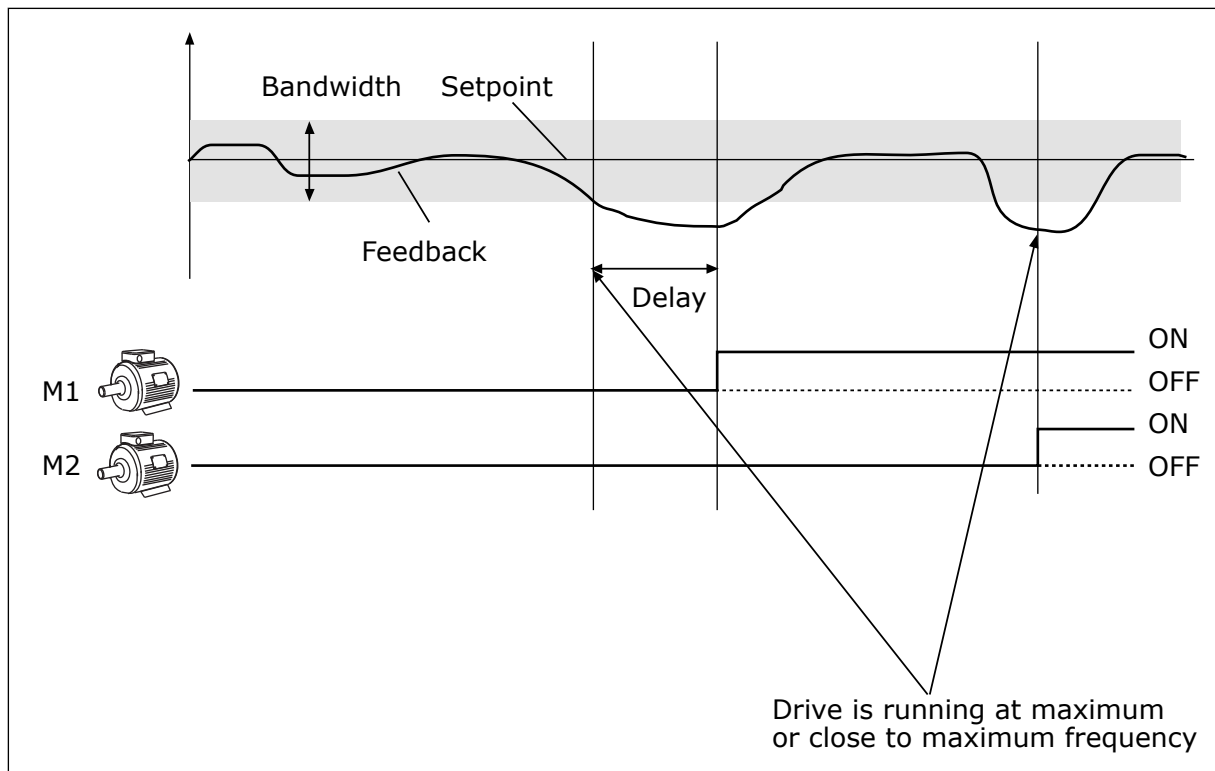

Fig. 40: The Multipump function

If the PID controller cannot keep the feedback in the set bandwidth, a motor or motors are connected or disconnected.

When to connect and/or add motors:

- The feedback value is not in the bandwidth area.
- The regulating motor operates at a close to maximum frequency (-2 Hz).
- The conditions above are true for longer than the bandwidth delay.
- There are more motors available

When to disconnect and/or remove motors:

- The feedback value is not in the bandwidth area.
- The regulating motor operates at a close to minimum frequency (+2 Hz).
- The conditions above are true for longer than the bandwidth delay.
- There are more motors that operate than the regulating one.

P3.14.2 INTERLOCK FUNCTION (ID 1032)

The interlocks tell the Multipump system that a motor is not available. This can occur when the motor is removed from the system for maintenance or bypassed for manual control.

To use the interlocks, enable the parameter P3.14.2. Make a selection of the status for each motor with a digital input (the parameters from P3.5.1.25 to P3.5.1.28). If the value of the input is CLOSED, that is, active, the motor is available for the Multipump system. If not, the Multipump logic will not connect it.

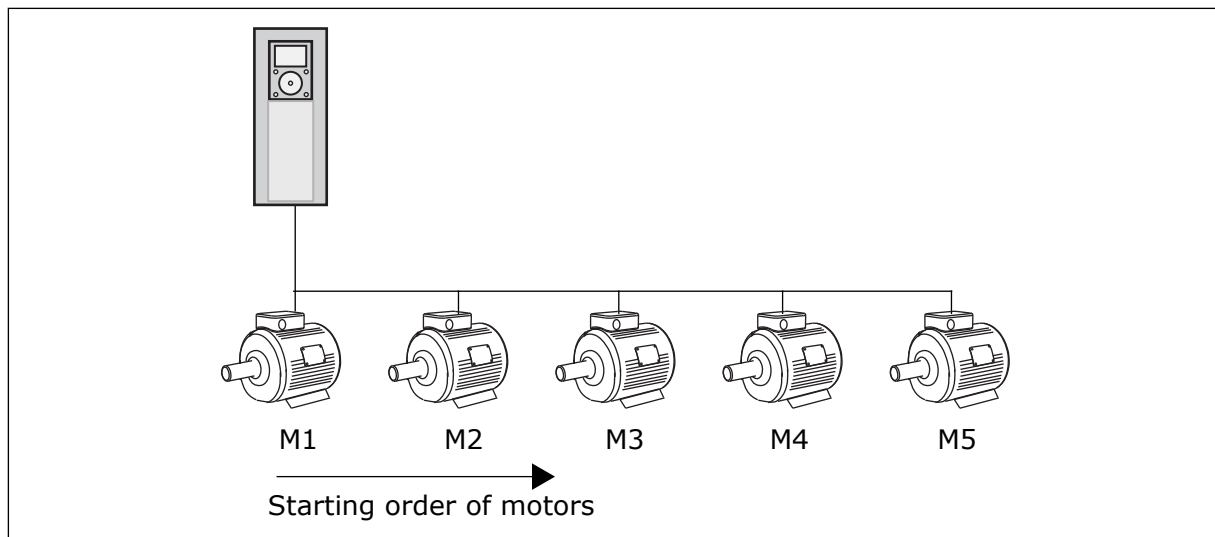

Fig. 41: The interlock logic 1

The sequence of the motors is **1, 2, 3, 4, 5**.

If you remove the interlock of Motor 3, that is, you set the value of P3.5.1.36 is set to OPEN, the sequence changes to **1, 2, 4, 5**.

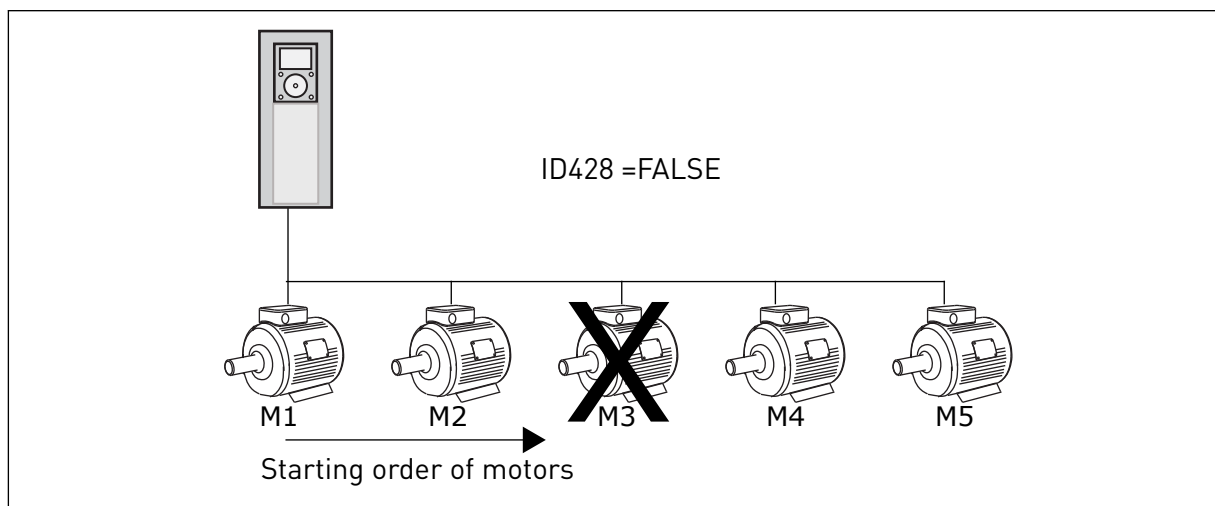

Fig. 42: The interlock logic 2

If you add Motor 3 again (you set the value of P3.5.1.36 to CLOSED), the system puts Motor 3 last in the sequence: **1, 2, 4, 5, 3**. The system does not stop, but continues to operate.

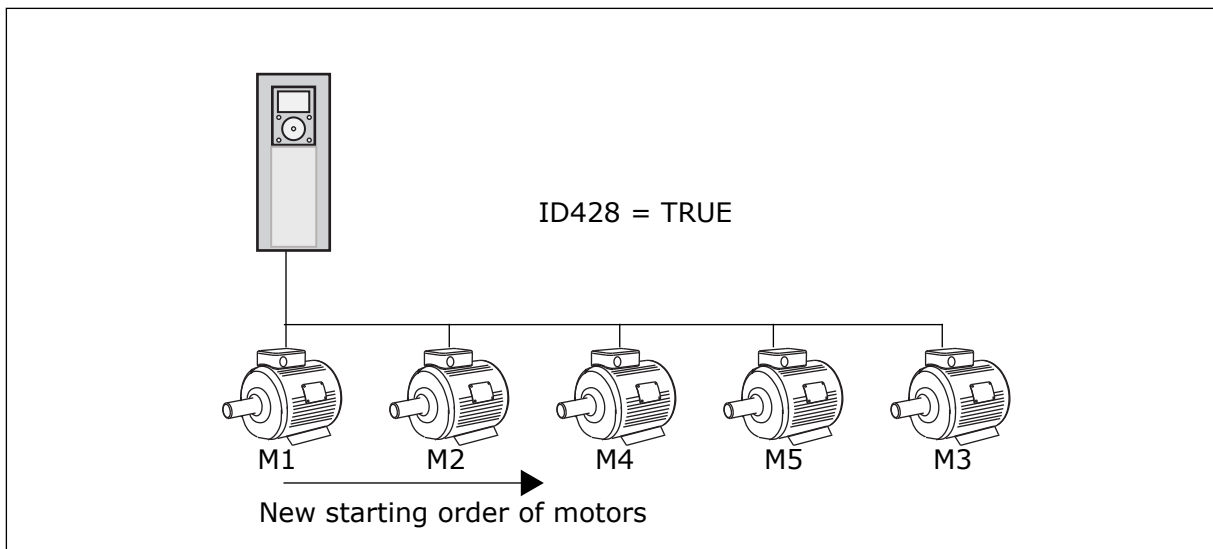

Fig. 43: The interlock logic 3

When the system stops or goes to sleep mode for the next time, the sequence changes back to **1, 2, 3, 4, 5**.

P3.14.3 INCLUDE FC (ID 1028)

Selection number	Selection name	Description
0	Disabled	The drive is always connected to Motor 1. The interlocks do not have an effect on Motor 1. Motor 1 is not included in the autochange logic.
1	Enabled	It is possible to connect the drive to any of the motors in the system. The interlocks have an effect on all the motors. All the motors are included in the autochange logic.

WIRING

The connections are different for the parameter values 0 and 1.

SELECTION 0, DISABLED

The drive is directly connected to Motor 1. The other motors are auxiliary motors. They are connected to the mains by contactors, and controlled by relays of the drive. The autochange or the interlock logic do not have an effect on Motor 1.

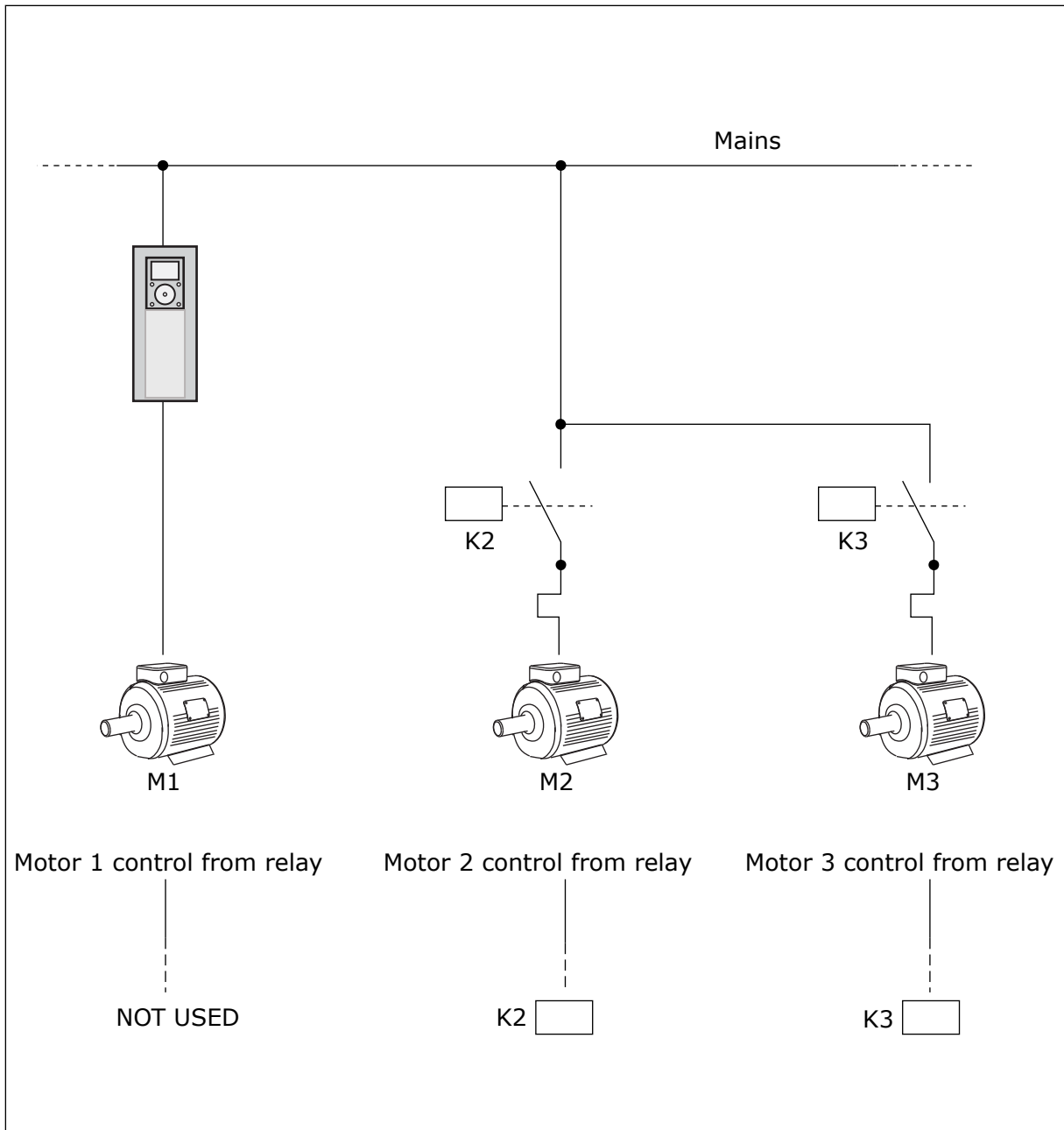

Fig. 44: Selection 0

SELECTION 1, ENABLED

To include the regulating motor in the autochange or in the interlock logic, obey the instructions in the figure below. 1 relay controls each motor. The contactor logic always connects the first motor to the drive, and the next motors to the mains.

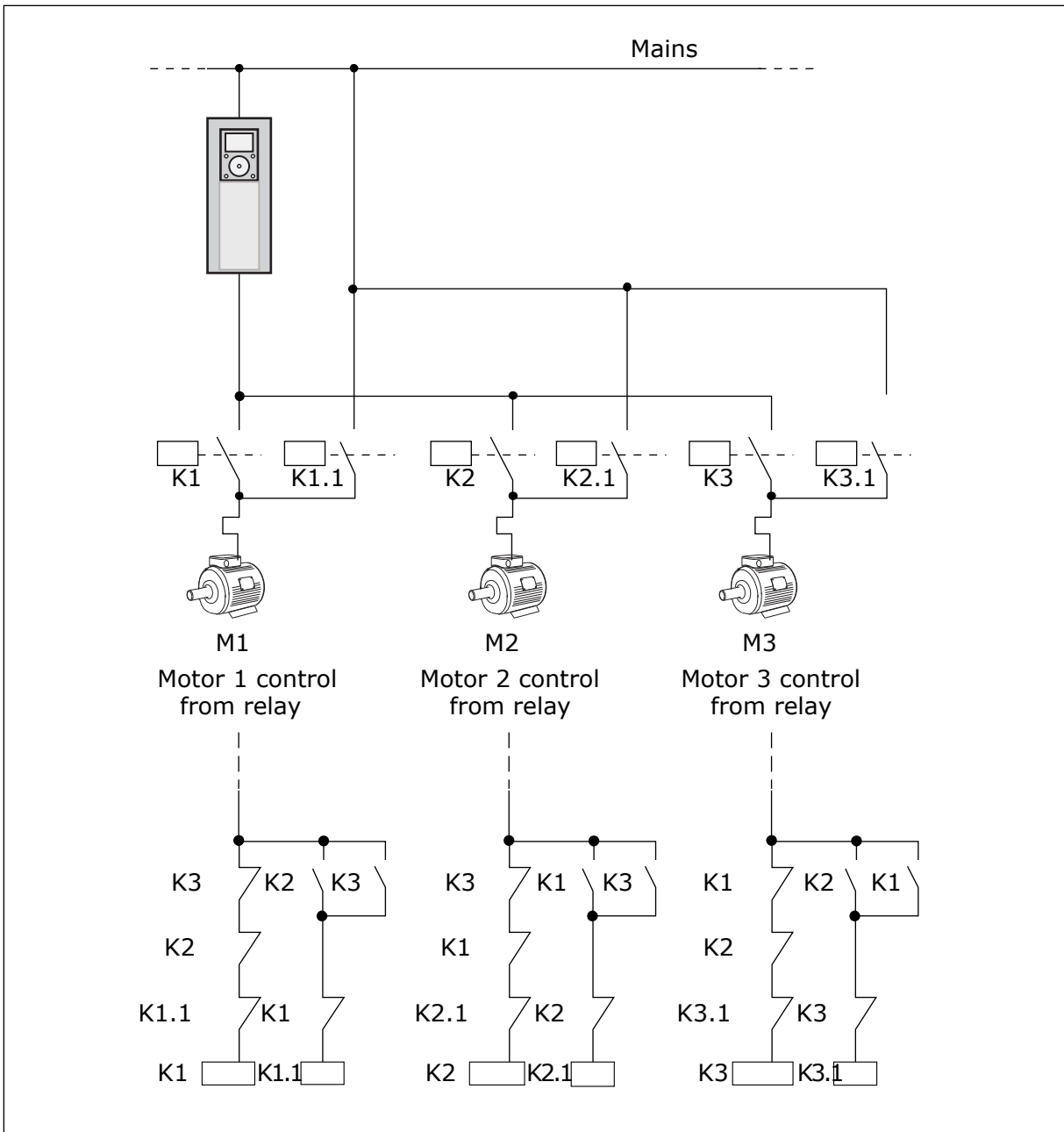

Fig. 45: Selection 1

P3.14.4 AUTOCHANGE (ID 1027)

Selection number	Selection name	Description
0	Disabled	In normal operation, the sequence of the motors is always 1, 2, 3, 4, 5 . The sequence can change during the operation if you add or remove interlocks. After the drive stops, the sequence always changes back.
1	Enabled	The system changes the sequence at intervals to wear the motors equally. You can adjust the intervals of the autochange.

To adjust the intervals of the autochange, use P3.14.5 Autochange Interval. You can set the maximum number of motors that can operate with parameter Autochange: Motor Limit (P3.14.7). You can also set the maximum frequency of the regulating motor (Autochange: Frequency Limit P3.14.6).

When the process is in the limits that are set with parameters P3.14.6 and P3.14.7, the autochange occurs. If process is not in these limits, the system will wait until the process is in the limits, and do the autochange after that. This prevents sudden pressure drops during the autochange when a high capacity at a pump station is necessary.

EXAMPLE

After an autochange, the first motor is put last. The other motors move up 1 position.

The start sequence of the motors: 1, 2, 3, 4, 5
--> Autochange -->

The start sequence of the motors: 2, 3, 4, 5, 1
--> Autochange -->

The start sequence of the motors: 3, 4, 5, 1, 2

9.13 FIRE MODE

When Fire mode is active, the drive resets all faults that occur and continues to operate at the same speed until it is not possible. The drive ignores all commands from the keypad, fieldbuses, and the PC tool.

The Fire mode function has 2 modes, the Test mode and the Enabled mode. To make a selection of a mode, write a password in parameter P3.16.1 (Fire Mode Password). In the Test mode, the drive does not automatically reset the faults, and the drive stops when a fault occurs.

**NOTE!**

This input is normally closed.

When you activate the Fire mode function, an alarm shows on the display.

**CAUTION!**

The warranty is void if the Fire mode function is activated! You can use Test mode to test the Fire mode function and the warranty stays valid.

P3.16.12 FIRE MODE RUN INDICATION CURRENT

This parameter has only effect if 'Run indication' is selected as the option for a relay output and the Fire mode is active. The 'Run indication' relay output functionality tells quickly if current is supplied to the motor during a fire.

The value of this parameter is the percentage counted from the motor nominal current. If there is a fire and the current that is supplied to the motor is more than the nominal current times the value of this parameter, the relay output closes.

For example, if the Motor nominal current is 5 A, and you set the default value 20 % for this parameter, the relay output closes and Fire Mode activates when the output current goes to 1 A.

**NOTE!**

This parameter does not have an effect if the Fire mode is not active. In normal operation, if you select 'Run indication' as the option for a relay output, the result is the same as when 'Run' is selected for the relay output.

9.14 APPLICATION SETTINGS***P3.17.4 FUNCT BUTTON CONFIGURATION***

This parameter tells which selections show when you push the Funct button.

- Local / Remote
- Control Page
- Change Direction (only visible in keypad control)

10 FAULT TRACING

When the control diagnostics of the AC drive find an unusual condition in the operation of the drive, the drive shows a notification about it. You can see the notification on the display of the control panel. The display shows the code, the name and a short description of the fault or alarm.

The source info tells you the source of the fault, what caused it, where it occurred, and other data.

There are 3 different types of notification.

- An info does not have an effect the operation of the drive. You must reset the info.
- An alarm informs you of unusual operation on the drive. It does not stop the drive. You must reset the alarm.
- A fault stops the drive. You must reset the drive and find a solution to the problem.

You can program different responses for some faults in the application. See more in Chapter 5.9 Group 3.9: Protections.

Reset the fault with the Reset button on the keypad, or through the I/O terminal, fieldbus or the PC tool. The faults stay in the Fault history where you can go and examine them. See the different fault codes in Chapter 10.3 Fault codes.

Before you contact the distributor or the factory because of unusual operation, prepare some data. Write down all the texts on the display, the fault code, the fault ID, the source info, the Active Faults list and the Fault History.

10.1 A FAULT COMES INTO VIEW

When the drive shows a fault and stops, examine the cause of fault, and reset the fault.

There are 2 procedures to reset a fault: with the Reset button and with a parameter.

RESETTING WITH THE RESET BUTTON

- 1 Push the Reset button on the keypad for 2 secods.

RESETTING WITH A PARAMETER IN THE GRAPHICAL DISPLAY

- 1 Go to the Diagnostics Menu.

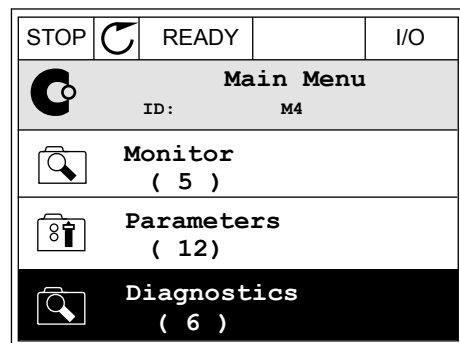

- Go to the submenu Reset faults.

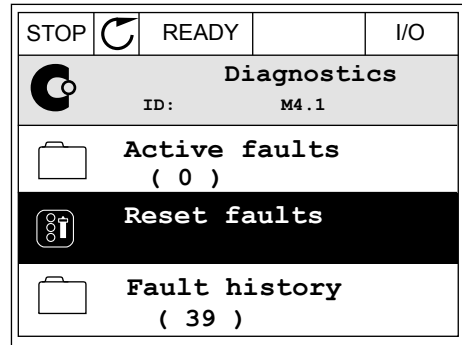

- Make a selection of the parameter Reset Faults.

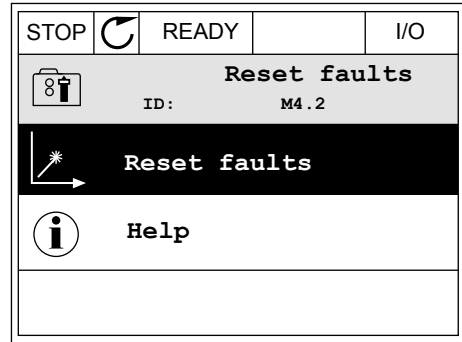

RESETTING WITH A PARAMETER IN THE TEXT DISPLAY

- Go to the Diagnostics menu.



- Use the arrow buttons Up and Down to find the parameter Reset Faults.

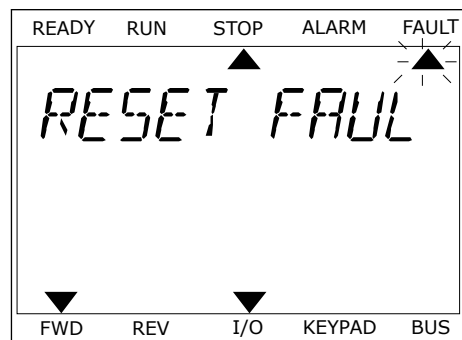

- 3 Make a selection of the value Yes and push OK.

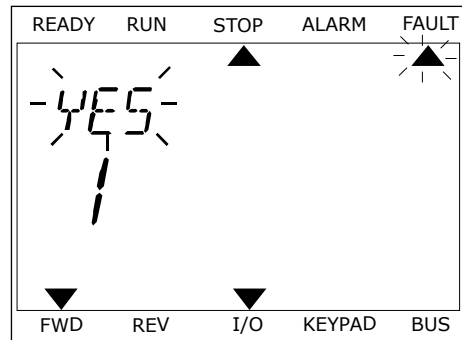

10.2 FAULT HISTORY

In the Fault history, you can find more data on the faults. There is a maximum number of 40 faults in the Fault history.

EXAMINING THE FAULT HISTORY IN THE GRAPHICAL DISPLAY

- 1 To see more data on a fault, go to Fault history.

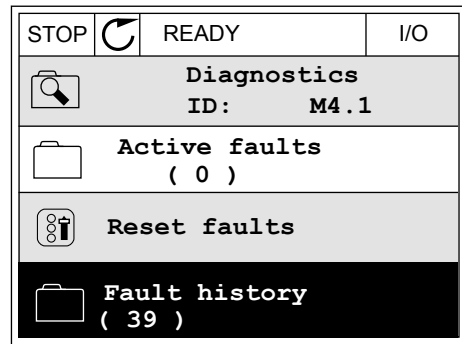

- 2 To examine the data of a fault, push the Arrow button Right.

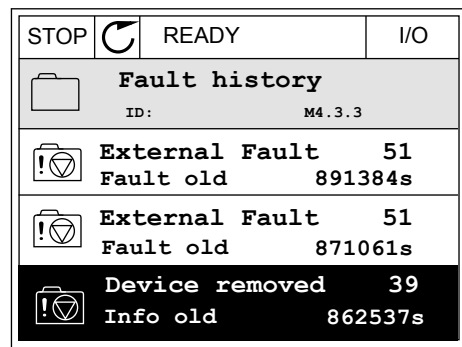

- You see the data in a list.

STOP	READY	I/O
Fault history		
ID:		M4.3.3.2
Code	39	
ID	380	
State	Info old	
Date	7.12.2009	
Time	04:46:33	
Operating time	862537s	
Source 1		
Source 2		
Source 3		

EXAMINING THE FAULT HISTORY IN THE TEXT DISPLAY

- Push OK to go to Fault history.

READY	RUN	STOP	ALARM	FAULT
▲				
FAULT HIST				
M4.3				
▼				
FWD	REV	I/O	KEYPAD	BUS

- To examine the data of a fault, push OK again.

READY	RUN	STOP	ALARM	FAULT
▲				
COMMUNICAT				
M4.3 1				
▼				
FWD	REV	I/O	KEYPAD	BUS

3 Use the arrow button down to examine all the data.

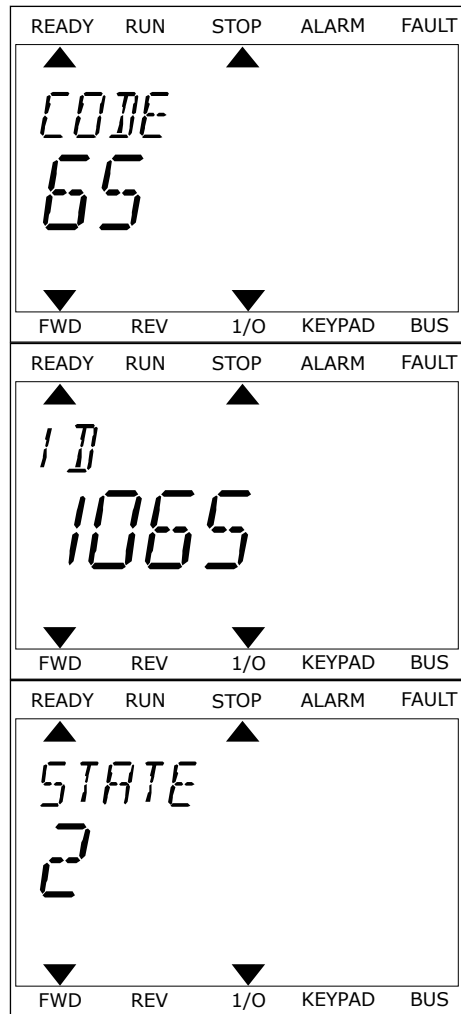

10.3 FAULT CODES

Table 61: Fault codes

Fault code	Fault ID	Fault name	Possible cause	How to correct the fault
1	1	Overcurrent (hardware fault)	There is too high a current (>4*I _H) in the motor cable. Its cause can be 1 of these. <ul style="list-style-type: none"> • a sudden heavy load increase • a short circuit in the motor cables • the motor is not the correct type 	Do a check of the loading. Do a check of the motor. Do a check of the cables and connections. Make an identification run. Do a check of the ramp times.
	2	Overcurrent (software fault)		
2	10	Overvoltage (hardware fault)	The DC-link voltage is higher than the limits. <ul style="list-style-type: none"> • too short a deceleration time • high overvoltage spikes in the supply • Start/Stop sequence too fast 	Set the deceleration time longer. Activate the overvoltage controller. Do a check of the input voltage.
	11	Overvoltage (software fault)		
3	20	Earth fault (hardware fault)	The measurement of current tells that the sum of the motor phase current is not zero. <ul style="list-style-type: none"> • an insulation malfunction in the cables or the motor 	Do a check of the motor cables and the motor.
	21	Earth fault (software fault)		
5	40	Charging switch	The charging switch is open, when the START command is given. <ul style="list-style-type: none"> • operation malfunction • defective component 	Reset the fault and restart the drive. If the fault occurs again, ask instructions from the distributor near to you.
7	60	Saturation	<ul style="list-style-type: none"> • Defective component 	This fault cannot be reset from the control panel. Switch off the power. DO NOT RESTART THE DRIVE or CONNECT THE POWER! Ask instructions from the factory. If this fault shows together with F1, do a check of the motor cables and motor.

Table 61: Fault codes

Fault code	Fault ID	Fault name	Possible cause	How to correct the fault
8	600	System fault	There is no communication between the control board and the power.	Reset the fault and restart the drive. If the fault occurs again, ask instructions from the distributor near to you.
	602		Watchdog has reset the CPU.	
	603		The voltage of auxiliary power in the power unit is too low.	
	604		Phase fault: Output phase voltage does not agree to the reference.	
	605		Fault in CPLD, but there is no detailed information about the fault.	
	606		The software of the control unit is not compatible with the software of the power unit.	Download the latest software from the Vacon website. Update the drive with it. If the fault occurs again, ask instructions from the distributor near to you.
	607		The software version cannot be read. There is no software in the power unit.	Update the power unit software. If the fault occurs again, ask instructions from the distributor near to you.
	608		A CPU overload. A part of the software (for example application) has caused an overload situation.	Reset the fault and restart. If the fault occurs again, ask instructions from the distributor near to you.
	609		Access to the memory is failed. For example, the retain variables could not be restored.	
	610		Necessary device properties cannot be read.	
	647	Software error.	Download the latest software from the Vacon website. Update the drive with it. If the fault occurs again, ask instructions from the distributor near to you.	
	648	Invalid function block is used in the application. The system software is not compatible with the application.		
	649	A resource overload. A parameter loading, restoring or saving malfunction.		

Table 61: Fault codes

Fault code	Fault ID	Fault name	Possible cause	How to correct the fault
9	80	Undervoltage (fault)	<p>The DC-link voltage is lower than the limits.</p> <ul style="list-style-type: none"> too low a supply voltage AC drive internal fault a defective input fuse the external charge switch is not closed <p>NOTE!</p> <p>This fault becomes active only if the drive is in Run state.</p>	<p>If there is a temporary supply voltage break, reset the fault and restart the drive. Do a check of the supply voltage. If the supply voltage is sufficient, there is an internal fault. Ask instructions from the distributor near to you.</p>
	81	Undervoltage (alarm)		
10	91	Input phase	The input line phase is missing.	Do a check of the supply voltage, the fuses and supply cable.
11	100	Output phase supervision	The measurement of current tells that there is no current in 1 motor phase.	Do a check of the motor cable and the motor.
13	120	AC drive undertemperature (fault)	<p>Too low a temperature in the heatsink of the power unit or in the power board. The heatsink temperature is less than -10 °C.</p>	
	121	AC drive undertemperature (alarm)		
14	130	AC drive overtemperature (fault, heatsink)	<p>Too high a temperature in the heatsink of the power unit or in the power board. The heatsink temperature is more than 100 °C.</p>	<p>Do a check of the actual quantity and flow of cooling air. Examine the heatsink for dust. Do a check of the ambient temperature. Make sure that the switching frequency is not too high in relation to the ambient temperature and the motor load.</p>
	131	AC drive overtemperature (alarm, heatsink)		
	132	AC drive overtemperature (fault, board)		
	133	AC drive overtemperature (alarm, board)		
15	140	Motor stalled	The motor stalled.	Do a check of the motor and the load.
16	150	Motor overtemperature	There is too heavy a load on the motor.	Decrease the motor load. If there is no motor overload, do a check of the temperature model parameters.
17	160	Motor underload	There is not a sufficient load on the motor.	Do a check of the load.

Table 61: Fault codes

Fault code	Fault ID	Fault name	Possible cause	How to correct the fault
19	180	Power overload (short-time supervision)	The power of the drive is too high.	Decrease the load.
	181	Power overload (long-time supervision)		
25		Motor control fault	A malfunction in the start angle identification. A generic motor control fault.	
30	290	Safe Off	The safe Off signal A does not let you to set the drive to the READY state.	Reset the fault and restart the drive. Do a check of the signals from the control board to the power unit and the D connector.
	291	Safe Off	The safe Off signal B does not let you to set the drive to the READY state.	
	500	Safety configuration	The safety configuration switch was installed.	Remove the safety configuration switch from the control board.
	501	Safety configuration	There are too many STO option boards. It is possible to have only 1.	Keep 1 of the STO option boards. Remove the others. See the safety manual.
	502	Safety configuration	The STO option board was installed in an incorrect slot.	Put the STO option board into the correct slot. See the safety manual.
	503	Safety configuration	There is no safety configuration switch on the control board.	Install the safety configuration switch on the control board. See the safety manual.
	504	Safety configuration	The safety configuration switch was installed incorrectly on the control board.	Install the safety configuration switch into the correct position on the control board. See the safety manual.
	505	Safety configuration	The safety configuration switch was installed incorrectly on the STO option board.	Do a check of the installation of the safety configuration switch on the STO option board. See the safety manual.
	506	Safety configuration	There is no communication with the STO option board.	Do a check of the installation of the STO option board. See the safety manual.
	507	Safety configuration	The STO option board is not compatible with the hardware.	Reset the drive and restart it. If the fault occurs again, ask instructions from your nearest distributor.

Table 61: Fault codes

Fault code	Fault ID	Fault name	Possible cause	How to correct the fault
30	520	Safety diagnostics	The STO inputs have a different status.	Do a check of the external safety switch. Do a check of the input connection and cable of the safety switch. Reset the drive and restart. If the fault occurs again, ask instructions from your nearest distributor.
	521	Safety diagnostics	A malfunction in the ATEX thermistor diagnostic. There is no connection in the ATEX thermistor input.	Reset the drive and restart. If the fault occurs again, change the option board.
	522	Safety diagnostics	A short-circuit in the connection of the ATEX thermistor input.	Do a check of the ATEX thermistor input connection. Do a check of the external ATEX connection. Do a check of the external ATEX thermistor.
	523	Safety diagnostics	A problem occurred in the internal safety circuit.	Reset the drive and restart. If the fault occurs again, ask instructions from your nearest distributor.
	524	Safety diagnostics	An overvoltage in the safety option board	Reset the drive and restart. If the fault occurs again, ask instructions from your nearest distributor.
	525	Safety diagnostics	An undervoltage in the safety option board	Reset the drive and restart. If the fault occurs again, ask instructions from your nearest distributor.
	526	Safety diagnostics	An internal malfunction in the safety option board CPU or in the memory handling	Reset the drive and restart. If the fault occurs again, ask instructions from your nearest distributor.
	527	Safety diagnostics	An internal malfunction in the safety function	Reset the drive and restart. If the fault occurs again, ask instructions from your nearest distributor.
	530	Safe torque off	An emergency stop was connected or some other STO operation was activated.	When the STO function is activated, the drive is in safe state.
32	312	Fan cooling	The fan life time is complete.	Replace the fan and reset the life time counter of the fan.
33		Fire mode enabled	The Fire mode of the drive is enabled. The protections of the drive are not used.	

Table 61: Fault codes

Fault code	Fault ID	Fault name	Possible cause	How to correct the fault
37	360	Device changed (same type)	The option board was replaced by a new one that you have used before in the same slot. The parameters are available in the drive.	The device is ready for use. The drive starts to use the old parameter settings.
38	370	Device added (same type)	The option board was added. You have used the same option board before in the same slot. The parameters are available in the drive.	The device is ready for use. The drive starts to use the old parameter settings.
39	380	Device removed	An option board was removed from the slot.	The device is not available. Reset the fault.
40	390	Device unknown	An unknown device was connected (the power unit/option board)	The device is not available.
41	400	IGBT temperature	The calculated IGBT temperature (unit temperature + I2T) is too high.	Do a check of the loading. Do a check of the motor size. Make an identification run.
43	420	Encoder fault	Encoder 1 channel A is missing.	Do a check of the encoder connections. Do a check of the encoder and encoder cable. Do a check of the encoder board. Do a check of the encoder frequency in the open loop.
	421		Encoder 1 channel B is missing.	
	422		Both encoder 1 channels are missing.	
	423		Encoder reversed.	
	424		Encoder board missing.	
44	430	Device changed (different type)	The option board was replaced by a new one that you have not used before in the same slot. No parameter settings are saved.	Set the power unit parameters again.
45	440	Device added (different type)	There is a new option board of a different type. No parameters are available in the settings.	Set the power unit parameters again.
51	1051	External fault	The digital input signal that is set with parameter P3.5.1.7 or P3.5.1.8 was activated.	

Table 61: Fault codes

Fault code	Fault ID	Fault name	Possible cause	How to correct the fault
52	1052	Keypad communication fault	The connection between the control panel and the drive is defective.	Do a check of the control panel connection and the control panel cable.
	1352			
53	1053	Fieldbus communication fault	The data connection between the fieldbus master and the fieldbus board is defective.	Do a check of the installation and fieldbus master.
54	1354	Slot A fault	A defective option board or slot	Do a check of the board and the slot.
	1454	Slot B fault		
	1654	Slot D fault		
	1754	Slot E fault		
65	1065	PC communication fault	The data connection between the PC and the drive is defective	
66	1066	Thermistor fault	The motor temperature increased.	Do a check of the motor cooling and the load. Do a check of the thermistor connection. If the thermistor input is not used, you have to short-circuit it.
69	1310	Fieldbus mapping error	The ID number that is used to map the values to Fieldbus Process Data Out is not valid.	Do a check of the parameters in the Fieldbus Data Mapping menu.
	1311		It is not possible to convert 1 or more values for Fieldbus Process Data Out.	The type of the value is undefined. Do a check of the parameters in the Fieldbus Data Mapping menu.
	1312		There is an overflow when the values for Fieldbus Process Data Out (16-bit) are mapped and converted.	
101	1101	Process supervision fault (PID1)	The PID controller: the feedback value is not in the supervision limits and the delay, if you set the delay.	
105	1105	Process supervision fault (PID2)	The PID controller: the feedback value is not in the supervision limits and the delay, if you set the delay.	

VACON[®]

DRIVEN BY DRIVES

Find your nearest Vacon office
on the Internet at:

www.vacon.com

Manual authoring:
documentation@vacon.com

Vacon Plc.
Runsorintie 7
65380 Vaasa
Finland

Subject to change without prior notice
© 2015 Vacon Plc.

Document ID:



Rev. J

Sales code: DOC-APP100HVAC+DLUK